

CONSTRUCTION STANDARD**FOR****CATHODIC PROTECTION****ORIGINAL EDITION****DEC. 1997**

This standard specification is reviewed and updated by the relevant technical committee on Jan. 2005(1) and Dec. 2013(2). The approved modifications are included in the present issue of IPS.

FOREWORD

The Iranian Petroleum Standards (IPS) reflect the views of the Iranian Ministry of Petroleum and are intended for use in the oil and gas production facilities, oil refineries, chemical and petrochemical plants, gas handling and processing installations and other such facilities.

IPS is based on internationally acceptable standards and includes selections from the items stipulated in the referenced standards. They are also supplemented by additional requirements and/or modifications based on the experience acquired by the Iranian Petroleum Industry and the local market availability. The options which are not specified in the text of the standards are itemized in data sheet/s, so that, the user can select his appropriate preferences therein

The IPS standards are therefore expected to be sufficiently flexible so that the users can adapt these standards to their requirements. However, they may not cover every requirement of each project. For such cases, an addendum to IPS Standard shall be prepared by the user which elaborates the particular requirements of the user. This addendum together with the relevant IPS shall form the job specification for the specific project or work.

The IPS is reviewed and up-dated approximately every five years. Each standards are subject to amendment or withdrawal, if required, thus the latest edition of IPS shall be applicable

The users of IPS are therefore requested to send their views and comments, including any addendum prepared for particular cases to the following address. These comments and recommendations will be reviewed by the relevant technical committee and in case of approval will be incorporated in the next revision of the standard.

Standards and Research department

No.17, Street14, North kheradmand

Karimkhan Avenue, Tehran, Iran.

Postal Code- 1585886851

Tel: 021-88810459-60 & 021-66153055

Fax: 021-88810462

Email: Standards@nioc.ir

GENERAL DEFINITIONS:

Throughout this Standard the following definitions shall apply.

COMPANY:

Refers to one of the related and/or affiliated companies of the Iranian Ministry of Petroleum such as National Iranian Oil Company, National Iranian Gas Company, National Petrochemical Company and National Iranian Oil Refinery And Distribution Company.

PURCHASER:

Means the "Company" where this standard is a part of direct purchaser order by the "Company", and the "Contractor" where this Standard is a part of contract documents.

VENDOR AND SUPPLIER:

Refers to firm or person who will supply and/or fabricate the equipment or material.

CONTRACTOR:

Refers to the persons, firm or company whose tender has been accepted by the company.

EXECUTOR:

Executor is the party which carries out all or part of construction and/or commissioning for the project.

INSPECTOR:

The Inspector referred to in this Standard is a person/persons or a body appointed in writing by the company for the inspection of fabrication and installation work.

SHALL:

Is used where a provision is mandatory.

SHOULD:

Is used where a provision is advisory only.

WILL:

Is normally used in connection with the action by the "Company" rather than by a contractor, supplier or vendor.

MAY:

Is used where a provision is completely discretionary.

CONTENTS:**PAGE No.**

1. SCOPE	1
2. REFERENCES	1
3. DEFINITIONS AND TERMINOLOGY	2
4. UNITS	8
5. GENERAL REQUIREMENTS	8
6. INSTALLATION OF CP SYSTEMS FOR BURIED PIPELINES	15
7. INSTALLATION OF CP SYSTEMS FOR COMPACT BURIED STRUCTURES	32
8. INSTALLATION OF CP SYSTEMS FOR INTERNAL SURFACES	34
9. INSTALLATION OF CP SYSTEMS FOR MARINE STRUCTURES	38
10. ELECTRICAL MEASUREMENTS AND TESTS.....	45
11. COMMISSIONING OF CATHODIC PROTECTION SYSTEMS	57
12. INSTALLATION OF ELECTRICAL ISOLATION EQUIPMENT	63
13. THERMIT WELDING OF CATHODIC PROTECTION LEADS	68

APPENDICES:

APPENDIX A CONTROL OF INTERFERENCE CURRENTS ON FOREIGN STRUCTURES.....	71
APPENDIX B MEASUREMENT OF SOIL RESISTIVITY.....	83
APPENDIX C MEASUREMENT OF ELECTRODE RESISTANCE.....	88
APPENDIX D CURRENT DRAINAGE SURVEY.....	91
APPENDIX E DETERMINATION IN-SITU OF THE REDOX POTENTIAL OF SOIL	93
APPENDIX F INSPECTION OF CP INSTALLATIONS.....	97
APPENDIX G INSTALLATION IN HAZARDOUS ATMOSPHERES	99

1. SCOPE

1.1 This Construction Standard covers the minimum requirements for installation, testing and commissioning of cathodic protection systems (impressed current and galvanic) for buried and immersed steel structures such as buried pipelines, distribution networks, in plant facilities, underground and ground and storage tanks and marine structures which includes installation, start-up, measurements, testing, commissioning and inspection procedures.

1.2 This Construction Standard is related to the [IPS-E-TP-820](#) and [IPS-I-TP-820](#) and shall be used in conjunction with those standards.

1.3 This Construction Standard is generally applicable to buried immersed steel structures. For specific structural systems (see Note), this Standard shall also be used in conjunction with the Company project specification and drawings for that structures. Any exceptions to the requirements of this Standard shall be stated in writing and submitted for approval to the Company representative.

1.4 The word "Structure(s)" hereafter in this Standard refers to steel structure(s) to be protected as mentioned above.

Note 1:

Installations that require special attention, techniques, and materials are not covered. Each such installation requires special considerations based on many influencing factors and cannot be covered adequately in a single standard.

Note 2:

This standard specification is reviewed and updated by the relevant technical committee on Jan. 2005. The approved modifications by T.C. were sent to IPS users as amendment No. 1 by circular No. 255 on Jan. 2005. These modifications are included in the present issue of IPS.

Note 3:

This standard specification is reviewed and updated by the relevant technical committee on Dec. 2013. The approved modifications by T.C. were sent to IPS users as amendment No. 2 by circular No. 412 on Dec. 2013. These modifications are included in the present issue of IPS.

2. REFERENCES

Throughout this Standard the following dated and undated standards/codes are referred to. These referenced documents shall, to the extent specified herein, form a part of this standard. For dated references, the edition cited applies. The applicability of changes in dated references that occur after the cited date shall be mutually agreed upon by the Company and the Vendor. For undated references, the latest edition of the referenced documents (including any supplements and amendments) applies.

BSI (BRITISH STANDARDS INSTITUTION)

BS 1377	"Methods of Tests for Soil for Civil Engineering Purposes" Part 3: Chemical and Electrochemical Tests Part 9: In-Situ Tests
BS EN62305-3	"Protection against Lightning Part 3: Physical Damage to Structures and Life Hazard"

BS EN13636	“Cathodic Protection of Buried Metallic Tanks and Related Piping”
BS 7430	“Code of Practice for Protective Earthing of Electrical Installations”

ASTM (AMERICAN SOCIETY FOR TESTING AND MATERIALS)

G 51	“Standard Test Method for PH of Soil for use in Corrosion Testing”
------	--

NACE(NATIONAL ASSOCIATION OF CORROSION ENGINEERS)

NACE RP 0572	“Standard Recommended Practice Design, Installation, Operation, and Maintenance of Impressed Current Deep Groundbeds”
--------------	---

IPS (IRANIAN PETROLEUM STANDARDS)

IPS-E-TP-820	“Engineering Standard for Cathodic Protection”
IPS-I-TP-820	“Inspection Standard for Monitoring Cathodic Protection Systems”
IPS-C-TP-274	“Construction Standard for Protective Coatings”
IPS-E-TP-270	“Engineering Standard for Protective Coatings For Buried And Submerged Steel Structures”
IPS-M-TP-750	“Materials and Equipment Standard for Cathodic Protection”
IPS-C-TP-102	“Construction Standard for Paintings”
IPS-M-EL-155	“Material and Equipment Standard for Transformer Rectifiers for Cathodic Protection”
IPS-E-EL-100/1	“Engineering Standard For Electrical System Design (Industrial And Non-Industrial)”

3. DEFINITIONS AND TERMINOLOGY

For the purposes of this Standard the following definitions shall apply:

Attenuation

The progressive decrease in potential and current density along buried or immersed pipeline in relation to distance from the point of injection.

Bonds:

Bond

A piece of metal conductor, either solid or flexible, usually of copper, connecting two points on the same or on different structures, to prevent any appreciable change in the potential of the one point with respect to the other.

Continuity bond

A bond designed and installed specifically to ensure the electrical continuity of a structure.

Note:

This may be permanent or temporary. In the latter case it is used to connect two sections of a structure which would otherwise be disconnected during a modification or repair.

Drainage bond

A bond to effect electric drainage.

Remedial bond

A bond installed between a primary and a secondary structure in order to eliminate or reduce corrosion interaction.

Resistance bond

A bond either incorporating resistors or of adequate resistance in itself to limit the flow of current.

Safety bond

A bond connecting the metallic framework or enclosure of electrical apparatus with earth, in order to limit its rise in potential above earth in the event of a fault, and so reduce the risk of electric shock to anyone touching the framework or enclosure.

Bond resistance

The ohmic resistance of a bond including the contact resistance at the points of attachment of its extremities.

Cathodic protection:

The process to reduce or prevent corrosion of metal structures in contact with an electrolyte by the flow of direct current from the electrolyte into the structure surface.

Cathodic protection station

A combination of equipment installed to provide cathodic protection to the structure(s).

Company-approved drawings

Company-approved drawings consist of appropriate standard drawings for cathodic protection (IPS-D-TP standards) and drawings prepared by the designer of the cathodic protection system to show the location and details for the construction of the CP system and appurtenances.

Current density

The amount of current per unit area of the steel surface coated or uncoated, in contact with the electrolyte.

Deep groundbed

One or more anodes installed vertically at a depth of 100 ft (30 m) or more below the earth's surface in a drilled hole for the purpose of supplying cathodic protection to the external surface of a metallic structure in contact with a common electrolyte.

Open hole (Deep groundbed)

An installation in which the anodes are surrounded only by an aqueous electrolyte.

Closed hole (Deep groundbed)

An installation in which the anodes have been surrounded by backfill.

Drain point

The point on the pipeline/structure where the connection of the negative terminal of the cathodic protection voltage source is made to conduct (drain) the returning current from the pipeline/structure to the voltage source.

Driving potential (of a sacrificial anode system)

The difference between the structure/electrolyte potential and the anode/electrolyte potential.

Electrolyte

A conductive liquid or material such as soil or water in which an electric current can flow.

Foreign structures

Metal structures, other than the structure under consideration, in contact with the same electrolyte as the structure, and which are or may become under the influence of the structure's cathodic protection system.

Foreign structures may be owned by the Company or other organizations and may or may not be equipped with cathodic protection.

Groundbed

The system of buried or submerged electrodes, to conduct the required current into and through the electrolyte to the steel surface to be protected.

Impressed current

The current supplied by a transformer/rectifier or other direct-current source (specifically excluding a sacrificial anode) to a protected structure in order to attain the necessary protection potential.

Instantaneous-off potential

The structure/electrolyte potential measured immediately after the synchronous interruption of all sources of applied cathodic protection current.

Joints:**– Isolating joint**

A joint or coupling between two lengths of pipe, inserted in order to provide electrical discontinuity between them.

– Insulated flange

A flanged joint between adjacent lengths of pipe in which the nuts and bolts are electrically insulated from one or both of the flanges and the jointing gasket is non-conducting, so that there is an electrical discontinuity in the pipeline at the point.

– **Interaction test**

A test to determine the severity of corrosion interaction between two buried or immersed structures.

– **Interference current**

In its broadest sense, a direct current flowing through paths other than the intended circuit. In this Construction Standard, interference current is current discharged to the electrolyte from a structure that may be either (1) not an intended part of the circuit or (2) if intended, then not adequately connected to the current source.

Midpoint

The point on a pipeline between two cathodic protection stations where the influence of the two cathodic protection stations is expected to be equal and the protection levels are usually lowest.

Natural potential

The pipe to soil potential measured when no cathodic protection is applied and polarization caused by cathodic protection is absent.

“Off” potential

The pipe to soil potential measured immediately after the cathodic protection system is switched off and the applied electrical current stops flowing to the pipeline surface, but before polarization of the pipeline has decreased.

“On” potential

The pipe to soil potential measured while the cathodic protection system is continuously operating.

PH value

The logarithm to base 10 of the reciprocal of the concentration of hydrogen ions in an aqueous solution. It provides a measure of the acidity or alkalinity of the solution on a scale reading from 0 to 14, on which 7 represents neutrality

Pipeline

The pipeline or pipelines with associated equipment as defined in the scope of the cathodic protection design contract.

Polarized potential

Pipe-to-soil potential free of errors caused by currents flowing from the applied cathodic protection system. The reading is normally measured within 100 milliseconds and 3 seconds of simultaneously switching off all cathodic protection current sources that may influence the measurement.

Polarization

The change of the pipe to soil potential caused by the flow of dc current between an electrolyte and a steel surface.

Potential gradient

Difference in potential between two points in the soil caused by current flowing off the pipeline and through the soil.

Reference electrodes:**Reference electrode**

An electrode the potential of which is accurately reproducible and which serves as a basis of comparison in the measurement of other electrode potentials.

Note:

Sometimes termed a "half cell".

Calomel reference electrode

A reference electrode consisting of mercury and mercury chloride (calomel) in a standard solution of potassium chloride.

Copper/copper sulphate reference electrode

A reference electrode consisting of copper in a saturated copper sulphate solution.

Silver/silver chloride reference electrode

A reference electrode consisting of silver, coated with silver chloride, in an electrolyte containing chloride ions.

Standard hydrogen electrode

A reference electrode consisting of an electro-positive metal, such as platinum, in an electrolyte containing hydrogen ions at unit activity and saturated with hydrogen gas at 1 atm.

Sensing electrode

A permanently-installed reference electrode used to measure the structure electrolyte potential and to provide a reference signal to control the protection current of an automatic impressed current system.

Resistivity

The electrical resistance of a unit volume of a material; the reciprocal of conductivity. Resistivity is used in preference to conductivity as an expression of the electrical character of soils (and waters) since it is expressed in whole numbers.

Resistivity measurements indicate the relative ability of a medium to carry electrical currents. When a metallic structure is immersed in a conductive medium, the ability of the medium to carry current will influence the magnitude of galvanic currents and cathodic protection currents. The degree of electrode polarization will also affect the size of such currents.

Specification:

Detailed procedures and requirements for the installation of the CP systems and appurtenances prepared by the Company designer. Installation specification may incorporate this Standard by reference, but should also include specification of the alternate provisions of the standard and requirements for matters not covered by the standard.

Redox potential

The equilibrium electrode potential for a reversible oxidation-reduction reaction used for assessing anaerobic microbial activity.

Remote earth

An electrode location far enough from the pipeline/structure that further separation results in no significant change in the circuit parameters.

Stray currents

Electrical currents running through the electrolyte, originating from a foreign dc source, causing interaction with the corrosion and cathodic protection processes of the pipeline. Stray currents may also originate from the pipeline's cathodic protection system and act upon foreign structures/pipelines.

Structures:**Protected structure**

Any metallic part to which cathodic protection is applied.

Unprotected structure

A structure to which cathodic protection is not applied.

Primary structure

A buried or immersed structure cathodically protected by a system that may constitute a source of corrosion interaction with another (secondary) structure.

Secondary structure

A buried or immersed structure that may be subject to corrosion interaction arising from the cathodic protection of another (the primary) structure.

Structure/electrolyte potential

The difference in potential between a structure and a specified reference electrode in contact with the electrolyte at a point sufficiently close to (but without actually touching) the structure to avoid error due to the voltage drop associated with any current flowing in the electrolyte.

Note:

Similar terms such as metal electrolyte potential, pipe electrolyte potential, pipe soil (water) potentials etc., as applicable in the particular context are also used.

Structure-to-structure voltage

(Also structure-to-structure potential). The difference in voltage between metallic structures in a common electrolyte.

Sulphate-reducing bacteria (SRB)

A group of bacteria found in most soils and natural waters, but active only in conditions of near neutrality and freedom from oxygen, which reduce sulphates in their environment with the production of sulphides.

Supplementary specifications

Supplementary specifications prepared by the Company to define which of the alternate materials and procedures provided in the standard and to provide for conditions, materials, and procedures not covered by this Standard.

Synchronized timer

A cyclic timer that can be synchronized to operate simultaneously with one or more other timers.

Abbreviations

Ag/AgCl	Silver/Silver Chloride as used for the Silver/Silver Chloride type of reference electrode.
Cu/CuSO ₄	Copper/Copper Sulphate as used for the Copper/Copper Sulphate type of reference electrode.
AC	Alternating Current.
DC	Direct Current.
CP	Cathodic Protection.
T/R	Transformer Rectifier.

4. UNITS

This Standard is based on International System of Units (SI), as per [IPS-E-GN-100](#) except where otherwise specified.

5. GENERAL REQUIREMENTS**5.1 Construction Works**

5.1.1 All construction works performed on cathodic protection systems shall be executed in strict accordance with the Company approved construction drawings and specifications.

5.1.2 All construction works performed on cathodic protection systems shall be under the supervision of a company inspector(s). It shall be the inspector's function to verify that the installation is made in strict accordance with the drawings and specifications (see 5.1.1). Any exceptions are made only with the express consent of qualified personnel where it can be demonstrated that the effectiveness of the system is not impaired. It shall also be the inspector's function to verify that construction methods and techniques are in accordance with good practices.

5.1.3 All works shall be executed in a workmanlike manner and shall present a neat, quality appearance when completed. All workmanship shall meet with the Company's approval. The contractor shall re-execute, at his own expense, all inferior workmanship which does not meet the approval of the Company.

5.2 Contractors Responsibilities

5.2.1 The work to be accomplished by the contractor includes furnishing qualified labor, materials, appliances, equipment, transportation, installation, supervision, and any services required to construct and complete cathodic protection system in accordance with the drawings and specifications that describe the installation.

5.2.2 The contractor works and duties normally include, but are not limited to, the following:

5.2.2.1 Supply of all construction materials which are not provided by Company.

5.2.2.2 Transport of the materials and equipment from the delivery locations up to the site and on site.

5.2.2.3 Installation, connection and checking of the cathodic protection systems including but not limited to:

- a) Concrete plinth for cathodic protection station equipment.
- b) Installation of T/rectifier(s).
- c) Trenching, laying and backfilling of ac and dc cables.
- d) Drilling, installation, connection and backfilling of anodes, deepwell(s) with concrete bases, if any.
- e) Installation, connection, and backfilling of anodes, horizontal and/or vertical groundbed(s), if any.
- f) Installation of ac supply box(es).
- g) Installation and connection of positive and negative test boxes.
- h) Connection of ac supply cables to fuse-disconnecting switch.
- i) Installation, connection and backfilling of galvanic anodes, if any.
- j) Installation and connection of current test box(es) for galvanic anodes, if any.

5.2.2.4 Reinstatement of the lands and surrounding area at CP equipment locations.

5.2.2.5 Cables connections to structure and reconditioning of structure coating at CP equipment locations.

5.2.2.6 Installation and connection of earthing circuit at CP station(s).

5.2.2.7 All the sundry works to complete the installation for the CP system(s).

5.2.2.8 Installation and connection of test boxes (bond boxes) at insulating joints/flanges, pipe crossing, etc.

5.2.2.9 Installation and connection of potential test points distributed on the structure.

5.2.3 The contractor shall set up and maintain such quality and inspection systems as are necessary to ensure that the goods and services supplied comply in all respects with the requirements of this Construction Standard. The Company shall assess such systems against the recommendations of the applicable parts of ISO 9002 or BS 5750 Part 2 and shall have the right to undertake such surveys as are necessary to ensure that the quality assurance and inspection systems are satisfactory.

5.2.4 The Contractor's personnel-in-charge of cathodic protection shall be fully qualified for this work. The contractor, before starting cathodic protection work shall submit qualifications of all his technical employees-in-charge of cathodic protection to the engineer for his approval. If any employee shows lack of knowledge in the function for which he is responsible, the engineer will require his immediate replacement and the contractor shall comply with the engineer's instructions without stopping the progress of the cathodic protection work.

5.2.5 The contractor shall ensure that the final installation of the CP system conforms to the Company-approved drawings and specification.

5.2.6 The contractor shall provide access to the work at all times for inspection by the Company.

5.2.7 The contractor shall bring to the attention of the Company project manager any areas of the drawings and specifications that conflict or do not meet safe and acceptable installation practices. The conflicts and exceptions shall be brought to the Company's attention and approval prior to installing any equipment involved and early enough to avoid adverse effects on the construction schedule. Deviations from design specifications shall be permanently recorded for future reference.

5.2.8 The contractor shall be responsible for keeping his work areas clean and free from debris and waste material at all times. The interior of all test boxes, T/R cabinets, etc., shall be cleaned of dust, dirt and loose materials.

5.2.9 The contractor shall check and energize the CP system(s).

5.2.10 After the complete installation of the cathodic protection systems, the contractor has to:

- Make a structure-to-soil potential survey before energizing.
- Adjust the CP station(s) to meet the potential level required.
- Make a structure-to-soil potentials survey at each test point along the structure.
- Check the insulation at pipe-casings (if any), insulating flanges/joints and all insulation at services.
- Make the influence measurements and take the necessary action to compensate the influence (if any).

5.3 Scheduling of Installation

The installation of permanent cathodic protection system needs to be co-ordinated with the piping, insulation, electrical, and instrument disciplines to ensure a proper completion. The installation of the cathodic protection system should begin only after the majority of mechanical construction is complete.

5.4 Materials Receiving, Storage and Handling

5.4.1 All materials provided by the Company and/or contractor shall be new and meet the requirements of relevant IPS standards such as [IPS-M-TP-750](#). All materials provided by contractor shall also meet the Company's approval.

5.4.2 The contractor shall take delivery of the items shown on the drawings, listed on the bill of materials and/or specified within the contract documents as company supplied materials. The contractor becomes responsible for company supplied materials, upon receipt by the contractor.

5.4.3 The contractor shall notify the Company of any discrepancies between the "actual materials received" and list of "Company Furnished Materials" within seven days of receipt of the materials, otherwise the contractor will be held responsible for having received all materials as listed.

5.4.4 All materials necessary for a complete operable installation not designated company supplied, shall be supplied and installed by the contractor. Any materials required or called for on the drawings and not listed in bill of materials shall be provided by the contractor. Verification of quantities listed on the bill of materials is expected at early stages of work.

All tools, measuring instruments and installation equipment for use by contractor shall be provided by himself.

5.4.5 It shall be the responsibility of the contractor to determine what materials he must expedite to maintain the agreed construction schedules.

5.4.6 It shall be the responsibility of the contractor to provide on site storage for all the equipment and materials to keep them clean, dry and free from possible hazards in the field prior to installation. Materials shall not be released to the field until they are needed for construction so as to minimize inadvertent damage.

All materials shall be stored above the ground so as to be kept free of dirt, grease, paint spray or

other foreign matter and shall be protected from corrosive environments and/or marine environmental.

5.4.7 Materials shall be stored in such a way as to enable Company representative to carry out quick stock checks at any time.

5.4.8 A material control system shall be maintained by contractor which will facilitate determining the balance and location of materials at all times.

5.4.9 All materials damaged or lost in handling, processing or storage must be repaired and/or replaced by contractor at his own expense.

5.4.10 The contractor shall be responsible for the safety, security, and condition of all equipment and materials from the time of delivery until commissioning is complete.

5.4.11 The contractor shall provide handling facilities for all equipment and installation materials during the construction period.

Notes:

1) Care shall be exercised in transportation and handling of transformer/rectifiers.

- Oil-cooled transformer/rectifiers shall be protected against the ingress of foreign material (storage by contractor).
- Air-cooled transformer/rectifiers can be stored in dry, protected areas without special treatment.

2) Special care shall be taken to avoid cracking or damaging anodes, wire and wire connection to anode during handling and installation.

Careful supervision of this phase is most essential to proper long-term performance of the cathodic protection system.

3) If graphite or high silicon cast iron anodes are used for groundbed construction, they shall be transported and handled with care because they are relatively brittle. The insulated leads furnished with the anodes by the manufacturer should be protected from damage to both the wire insulation and the connection between wire and anode. Although these connections are well made, it is not the best practice to support the full anode weight by the lead wire alone; although the connection may not fail mechanically, the strain may be sufficient to damage insulating material at the connection enough to permit current leakage that would cause corrosion failure of the connection.

5.5 Materials and Equipment Acceptance (or Compliance)

5.5.1 General

The contractor shall inspect all materials and equipment upon receipt. Any damaged or missing items shall be reported by the contractor to the Company representative. Because of the inaccessible nature of much of the cathodic protection equipment in service, it is necessary to confirm, prior to shipment to site and prior to installation, that materials and equipment comply with the appropriate standard specification (see [IPS-M-TP-750](#)). Clauses 5.5.2 to 5.5.6 inclusive indicate the types of checks and tests which shall be undertaken by contractor to avoid unnecessary and protracted delays while replacements are sought or repairs are undertaken.

5.5.2 Galvanic anodes

5.5.2.1 Anodes should be inspected for the following:

- a) Freedom from electrical damage crack and porosity.

- b) Electrical security and continuity of connections.
- c) Anode to core continuity.
- d) Correct metal mass.
- e) Correct profile.
- f) Compliance of anodes (including anode backfill) with [IPS-M-TP-750](#).

5.5.2.2 Insulation of all cable tails shall be inspected for presence of nicks, cuts or other forms of damage.

5.5.2.3 Packaged anodes shall be inspected and steps taken to assure that backfill material completely surrounds the anode. The individual container for the backfill material and anode should be intact. If individually packaged anodes are supplied in waterproof containers, that container must be removed before installation. Packaged anodes should be kept dry during storage.

5.5.2.4 Electrical continuity between anode and lead wire shall be tested without compromising the integrity of the package.

5.5.2.5 Other galvanic anodes, such as unpackaged "Bracelet" type or ribbon, should be inspected for assurance that dimensions conform to design specifications and that any damage during handling does not affect application. If a coating is used on bands and the inner side of "Bracelet" anode segments, it should be inspected and, if damaged, repaired before the anodes are installed.

5.5.2.6 When a separate suspension such as rope is used to support the weight of an anode, the suspension system should be inspected for damage and all defects repaired.

5.5.2.7 In the case of weld-on type galvanic anodes, the steel cores shall be inspected for conformance to specifications. If the anode cores have welded joints or connections, these shall be inspected to assure compliance with structure welding specifications.

5.5.2.8 When galvanic anode suspension cables are used for the lead wire, the cables shall be inspected for strength and good electrical contact with the anode. Where separate suspension cables are used, care shall be taken to insure that anode lead wires are not in such tension to damage the lead wires or connections.

5.5.2.9 If coatings are specified for galvanic anode supports or suspension cables, they shall be visually inspected and the coatings repaired if damaged.

5.5.3 Impressed current anodes

5.5.3.1 Impressed current anodes shall be inspected for conformance to standard specifications (see [IPS-M-TP-750](#)) concerning correct anode material and size, length of lead wire, and secure cap, if used. Care shall be exercised to avoid cracking or damaging or scratching (for mmo and ds) anodes during handling and installation.

5.5.3.2 Lead wire shall be carefully inspected to detect defects in insulation. Care shall be taken to avoid damage to insulation on wire. Defects in the lead wire must be repaired or the anode must be rejected.

5.5.3.3 Anode backfill material shall conform to standard specifications (see [IPS-M-TP-750](#)).

5.5.4 Cables

5.5.4.1 Cables shall be inspected to ensure that cable runs can be achieved, preferably in one take-off from a reel or drum and that the cable is of correct construction for the intended application.

5.5.4.2 Insulation of all cables should be inspected for presence of nicks, cuts, cracks, abrasions, excessive thinning below specified thickness or other forms of damage.

5.5.4.3 Cable material shall conform to standard specifications (see [IPS-M-TP-750](#)).

5.5.5 Transformer/rectifier equipment

Testing should be carried out prior to acceptance of a transformer/rectifier unit, to confirm compliance with the standard specification (see [IPS-M-EL-155](#)) and to ensure that the equipment is suitable for the intended purpose.

The following tests shall be carried out on transformer/rectifier equipment:

- a) Visual inspection to ensure that all rectifier and surge protection equipment and all specified current outputs, have been provided.
- b) Polarity check to ensure that output terminals are correctly identified.
- c) A step-by-step check of the unit output against calculated load, to ensure that a uniform control pattern is available.
- d) Insulation resistance tests shall be conducted and recorded on all transformer/rectifier(s) in accordance with company-approved testing method to ensure that the equipment has neither deteriorated nor been damaged during shipment.
- e) The contractor shall ensure that oil-cooled transformer/rectifier(s) are filled to the normal liquid level before being placed in operation. Five samples of insulation oil should be tested for dielectric strength and have the results and the average recorded if required by the Company.
- f) Functional tests of time switches to be installed.
- g) Functional tests of other special equipment to be fitted.

5.5.6 Prefabricated insulating joints

Where appropriate, each insulating joint shall be electrically tested, pressure tested, and finally electrically re-tested. Where supplied for welding into position, the associated pipe pieces shall be of sufficient length to prevent damage to the joint insulation by heat transfer during the welding process. During welding the manufacturer's recommendations on cooling rate shall be followed.

5.5.7 Insulating joint shall conform to standard specifications (see [IPS-M-TP-750](#)).

5.6 Drawings

5.6.1 Location of equipment

The location drawing(s) indicate the extent and general arrangement of the cathodic protection systems. Exact locations, distances and levels will be governed by actual field conditions. The contractor shall verify all dimensions in the field for company approval prior to installation.

5.6.2 Other systems

The contractor shall be responsible to examine the architectural, mechanical and structural drawings to determine if any interferences or discrepancies arise. Any interferences or discrepancies found shall be reported to the Company as soon as practicable.

5.6.3 Changes

If any departures from the original intent of the drawings and/or specifications are deemed necessary by the contractor, details of such departures with drawings, if necessary, together with reasons for the departure shall be submitted to the Company as soon as practicable for approval. No such departure shall be made without the prior written consent of the Company.

5.6.4 As-built

5.6.4.1 A set of as-built construction drawings shall be marked up, by the contractor in red on a daily basis. The Company shall have access to view this set of drawings at all times.

5.6.4.2 Before final acceptance of the work, the contractor shall furnish the Company with one completely detailed set of "as built" drawings showing final locations and connections for all work carried out by the contractor. Such as-built drawings will include all pertinent notes and dimensions necessary to show clearly the location of all equipment and connections.

5.6.4.3 As-built drawings will be verified and shall not be deemed complete until they are to the satisfaction of the Company.

5.6.5 Wiring diagram

The contractor shall be responsible to examine the architectural, mechanical and structural drawings to issue wiring Diagram and cable schedule for cathodic protection.

5.7 Excavation and Backfilling

5.7.1 The contractor shall provide all necessary excavating, shoring, sheathing, bracing, pumping and backfilling required to install groundbeds, cables and connections as specified. when excavation is carried below grade, the fill to grade material shall be well tamped in such a manner as to meet the approval of the Company. In no case shall any frozen earth be used for backfilling, nor shall any backfilling be placed on or against frozen earth. Trenches under roads and paved areas shall be backfilled with coarse sand to the approval of the Company. Excavated material shall not be used.

5.7.2 Any earth excavating procedure presents safety hazards related to the presence of unstable soils, water, released products, and moving equipment. Personnel involved in excavation, equipment installation, and bacfilling shall be knowledgeable about and shall follow the safety standards.

5.7.3 The excavation shall provide adequate space for the installation of anodes, cables, and ancillary equipment.

5.7.4 Special attention shall be given to sloping or shoring the sides of the excavation to make them stable.

5.7.5 Metallic pipelines shall be located through use of a line locator and mechanical probe. Excavations within 600 mm of pipe shall be done by hand.

Non-metallic lines in the immediate proximity of excavations shall be exposed by hand.

5.7.6 Damage to pipelines, coatings, conduit, cable or other buried equipment as a result of excavation shall be repaired in accordance with [IPS-C-TP-274](#) at cost to the contractor prior to backfilling.

5.8 Painting

The contractor shall touch-up all electrical and control equipment marred by shipment or erection, using the same color and type of finish as the original-according to Company standard for painting (see [IPS-C-TP-102](#)). The transformer/- rectifier cabinet must not be coated with mastics, tars, or any other like materials.

5.9 Return of Unused Materials and Equipment to Company

At the end of the work contractor shall provide a list of unused materials and equipment for company representative for return of them to Company store allocated for the purpose.

6. INSTALLATION OF CP SYSTEMS FOR BURIED PIPELINES

6.1 General

This Clause 6 specifies minimum requirements for the installation of cathodic protection systems that will control corrosion of the buried pipelines.

6.2 Installation of Impressed Current Systems

6.2.1 Groundbeds

6.2.1.1 Because anodes are often brittle, care shall be exercised to ensure that they are not damaged by handling. Unless especially designed, they shall not be suspended or lowered by their cable tails because connections are essentially electrical and not mechanical.

6.2.1.2 Proper implements, tools, and facilities shall be provided and used for the safe and convenient performance of the work.

6.2.1.3 All materials shall be examined carefully for damage and other defects immediately before installation. Defective materials shall be marked and held for inspection by the Company, who may prescribe corrective repairs or reject the materials.

6.2.1.4 Anodes shall be installed in the center of any backfill and the backfill shall be gently tamped into place around the anode. Care shall be taken to prevent anode breakage.

6.2.1.5 On completion of the installation of a groundbed, the resistance of the groundbed to remote earth should preferably be measured by using an alternating current earth tester. Measured resistance should be compared with the design resistance.

6.2.1.6 Resistance in a groundbed may be lowered by permanent adding water to each anode by using plastics water piping and drip-irrigation fittings. However, where groundbed resistance is still too high, the groundbed will need to be extended.

6.2.1.7 The groundbeds shall be of the following forms as will be specified by the design documents.

6.2.1.7.1 Horizontal groundbed

Horizontal groundbeds shall be constructed in locations as determined in the design drawings and with the following considerations:

a) Anodes shall be installed horizontally in a group and connected in parallel in the trench at a minimum depth of 2000 mm and at 4500 mm centers spacing, unless otherwise specified by the design documents (see standard drawing No. IPS-D-TP-706).

b) A bedding of the trench shall be made 600 mm wide and with depth and length as specified on the design drawings. The trench walls shall be vertical throughout and the bedding shall be tamped to provide a uniform surface.

c) Anodes shall be installed with a minimum of 150 mm compacted metallurgical grade coke breeze encapsulating (canister) the circumference and a minimum of 2250 mm coke breeze extending beyond each end. The anodes lead wires shall then be brought out of the coke breeze and spliced, taped, and coated to the positive header cable (see 6.2.4.2).

d) The coke breeze shall be thoroughly and properly tamped; for maximum coupling between anode and earth. Care shall be exercised during backfilling to avoid damage to the anode. Loose backfill can give disappointingly high resistances and shorten anode life.

e) The process of tamping down shall be achieved in stages after every 10 cm layer of coke breeze has been poured into the trench. The tamping down process while having to be very thorough shall in no way damage the anodes.

The groundbed excavation shall then be backfilled with fine soil by hand until a minimum cover of 200 mm over coke breeze is achieved. Power equipment shall then be used to restore the excavation to original ground level.

Before backfilling the trench, the vent pipes shall be placed at their predetermined locations on each anode and filled with gravel.

If the backfilling operation does not produce sufficient compaction to eliminate the possibility of future settling, a berm shall be installed over the backfill such that original elevations will be met.

f) The header cable shall then be laid on 100 mm layer of fine sand covered with a further 100 mm of sand. The remaining space of the trench shall be backfilled with earth to ground level. For the protection of the cable, protective tiles or bricks shall then be installed on top of the sand as shown on the standard drawing. The remaining space of the cable trench shall be filled with backfill.

Notes:

1) In horizontal installations, ditch width at anode depth shall be that of the design width of the carbonaceous backfill layer. Where this is not possible because of trenching conditions, form boards may be used to restrict the backfill. After the carbonaceous material and anodes have been placed inside the form boards and tamped earth outside, the form boards must be withdrawn. The coke breeze shall be retamped to fill the space occupied by the form boards.

2) Top soil shall be stripped and stockpiled at the commencement of excavating and redistributed over the excavated area upon completion.

3) Maximum anode loading shall be determined by employing good engineering practices.

4) The contractor shall give due consideration to the use of anode irrigation equipment. Where applicable, complete details of proposed equipment and installation methods shall be provided for approval of the Company.

5) The groundbed shall be located at the distance from any buried metal structure as specified by the design documents with reference to [IPS-E-TP-820](#). When possible the distance shall not be less than 100 m.

6.2.1.7.2 Vertical groundbed

Vertical groundbeds shall be constructed in locations as determined in design drawings and with the following considerations:

a) Anodes shall be installed vertically in a group (at straight line) in separate holes and connected in parallel as shown in the standard drawing No. IPS-D-TP-705.

b) The anode hole shall be at least 1300 mm (4 ft) deeper than the length of the anode rod and 200 mm (8 in) more in diameter than the diameter of the anode.

c) The bottom of the hole shall be filled to a depth of 300 mm (1 ft) of metallurgical grade coke breeze, and tamped until well packed. Tamping will reduce the anode-to-soil resistance, thereby increasing the efficiency of the installation. The anode must be centered carefully in hole, and the backfill material shall be poured into the hole to cover the anode. The backfill shall be gently tamped into place around the anode. When tamping with power tampers (preferred) or by hand, particular care must be exercised to prevent damage to the anode or anode lead wire.

d) This procedure is repeated until the anode is covered by at least 300 mm (1 ft) of backfill. After making the electrical connection of anode lead wire to header cable the vent pipe shall be placed in its predetermined location and filled with gravel.

Note:

The purpose of the gravel is to provide a gas vent for the oxygen, chlorine and, in some special cases, hydrogen, which may evolve under various conditions from the anode area.

e) The hole shall then be backfilled with the excavated earth to ground level. The header cable shall be laid on 100 mm layer of fine sand covered with a further 100 mm of sand. For the protection of the cable, protective tiles or bricks shall be installed on top of the sand as shown on the standard drawing. The remaining space of the cable trench shall be filled with backfill.

Note:

(See Notes 2, 3, 4 and 5 of paragraph 6.2.1.7.1).

6.2.1.7.3 Deep-well groundbed

6.2.1.7.3.1 General

Deep-well groundbeds shall be constructed in locations as determined in the design drawings, and with the following considerations:

- a) The anode bed for a deep-well groundbed shall be drilled with a rotary rig (using mud or air) or by cable tools where applicable.
- b) Depending on the type of drilling rig used, it may be possible to use the rig itself for placing the anode system in the hole where a well is being drilled in soft formations which cannot be depended on to hold an open hole without collapsing, a rotary rig can continue circulating drilling mud in the hole, after reaching design depth, until just prior to placing the anode system.
- c) All drilling procedure and installation of casing and well head completions shall be in accordance with public laws.
- d) Casing shall be set prior to installation of anodes to prevent damage to the lead wires.
- e) Downhole components shall not be bundled or fastened with materials that will cause gas entrapment or backfill bridging.
- f) The lead wire-to-anode connection resistance shall be checked before installation.
- g) The lead wire insulation must be protected from abrasion and sharp objects. Prior to installation, lead wire insulation shall be visually inspected for flaws or damage.
- h) Further assurance of lead wire insulation integrity may be achieved by conducting suitable wet tests using proper safety precautions.
- i) When installing a suspended anode, where separate suspension is required, care shall be exercised to ensure that the lead wire is not in sufficient tension to damage the anode lead wire or connections.
- j) The deep-well shall be either dry (closed hole) or wet (open hole) type as specified by design documents.
- k) For installation of lead wire in areas with halogen or other corrosive gases or ions are expected to exist in the electrolyte, a specialized, chemical-resistant insulation material such as (PVDF), (XLPVDF), (ECTFE), (XLECTFE), or other inert fluorocarbon or halogenated material shall be used. Outer insulation jackets should be used for mechanical protection such as HMWPE. (Ref. NACE-RP-0572).

Notes:

- 1) When possible, the groundbeds shall be located at a minimum distance of thirty meters (30 m) from any buried metal structures.
- 2) Addition of salt to deep well groundbeds for the purpose of lowering the resistance of the groundbed is absolutely forbidden.

6.2.1.7.3.2 Closed well (closed hole)

- a) Individual string anodes shall be centered in the well with a suitable device centralized that will allow passage of backfill material, will not entrap gases, and will not damage lead wire insulation or preclude proper placement of anodes. The installation details shall be as per standard drawing IPS-D-TP-713.
- b) Before pumping backfill material, place all anodes at the predetermined depth and set the vent pipe from the bottom anode to the top of the well.
- c) Before pouring or shoveling backfill material from the top of the well, displace the drilling mud with clear water, and place the vent pipe and two deepest anodes at their predetermined depth. Pour backfill material into the well to cover first anode, place the third anode, and repeat the procedure for each following anode.
- d) Wetting the backfill material may be required to prevent bridging the well.
- e) If strata resistivities permit moderate vertical shifting of anode position, the release of anode lead wire tension to provide slack may prevent excessive loading of the lead wire or the lead wire-to-anode connection in the event of caving or settling of the backfill material.
- f) Type 3 coke breeze of [IPS-M-TP-750](#): Part 2 shall be used as backfill unless specified otherwise by Company.
- g) All deep groundbed installations (rectifier, well and venting location) shall be marked with adequate signs advising all personnel to vent the installation properly before commencing work and to keep fire away.
- h) The use of one plastic vent pipe will aid in dissipating gases to the atmosphere.
- i) The plastic vent pipe that extend below anodes normally have a series of small holes on 15 to 30 cm centers drilled in the immediate vicinity of the anodes. These holes shall be of such a small diameter as to prevent entry of the backfill material into the vent pipe.
- j) The vent pipe shall be capped at both ends during the backfilling operation to minimize filling with backfill material or mud.
- k) A threaded fitting installed at the surface end of the vent pipe will facilitate water or air injections which may be required to eliminate gas blockage. The use of a screened bushing on the threaded fitting will prevent entry of insects and foreign objects. The connection of a hose to the vent pipe with the end inserted in an open water container will provide a visible test of gas venting.
- l) Vent pipes shall be located so as to preclude the entry of corrosive gases into the test box and rectifier. All lead wire conduits shall be sealed.
- m) A uniformly low resistivity backfill (see f) shall be installed in the well until the top anode is adequately covered. Suitable backfill will decrease the anode resistance to the electrolyte, increase anode life, prevent caving, and facilitate gas venting. The remainder of the well shall be filled with a nonconductive, nonabrasive permeable backfill material (sand or pea gravel).
- n) Backfilling may be accomplished by pumping, shoveling, or pouring. Backfilling method usually is determined by the characteristics of the strata and the backfill material used.
- o) Presoaking of the backfill material with water is recommended to minimize the possibility of bridging. A wetting agent may be used.
- p) Backfilling of wells containing drilling mud and/or water may be accomplished by pumping the backfill material (in slurry form) to the bottom of the well and allowing the well to fill from the bottom up to displace the drilling mud and/or water.
- q) Observations of the change in anode resistance to earth shall be used to determine if the backfill material has been placed around the anode.

6.2.1.7.3.3 Open well (open hole)

- a) Each anode shall be suspended, placed in position, raised, lowered, or removed for inspection by individual polypropylene rope (see [IPS-M-TP-750](#): Part 10).
- b) Anodes shall be centered in the casing, considering the required spacing between them, within the aqueous electrolyte as detailed in the standard drawing No. IPS-D-TP-707.
- c) The final depth of the well will depend on the subsurface strata and the number and length of the anodes. The approximate depth shall be defined by the designer. Necessary precautions shall be taken to prevent deleterious modification of ground water quality.
- d) Each anode shall be provided with an individual insulated lead wire or, a cable sufficiently long shall be connected to the anode-lead-wire with cable connector (line tap) and in-line (2 way) splicing kit (see IPS-M-TP-750: Part 11).
- e) Each cable group of each deepwell shall be brought inside the positive test box (type 2) located at the deepwell head.
- f) The test box shall be installed as per standard drawing No. IPS-D-TP-702 for individual termination of anodes and rectifier positive lead wires.
- g) A shunt should be installed in each anode circuit to monitor the current output.
- h) Resistors should be installed in individual anode circuits to balance anode outputs.
- i) Sealing of anode wires to prevent capillary action between insulation layers may be necessary to prevent corrosive elements from entering the test box.
- j) Sealing lead wire entry may be necessary to prevent entry of gases.

6.2.2 Installation of transformer/rectifier equipment

6.2.2.1 Transformer/rectifier(s) should comply with [IPS-M-EL-155](#).

6.2.2.2 It is essential that the transformer/rectifier units will be installed by suitably qualified personnel and are installed in accordance with the requirements of National Electrical Code NFPA-70, Latest Edition and this Standard.

6.2.2.3 Manufacturer's installation and operating manuals shall be available at site prior to installation of the transformer/ rectifier. The instructions contained therein shall be adhered to.

6.2.2.4 Air-cooled transformer/rectifier(s) shall be installed pole mounted by means of using four roll and plug type connectors and in a free place for cooling purposes.

6.2.2.5 Oil-cooled transformer/rectifier(s) shall be installed in non-hazardous areas and away from any equipment which creates heat.

6.2.2.6 Oil-cooled transformer/rectifier(s) shall be installed on a concrete plinth in accordance with the details specified by standard drawings IPS-D-TP-701 or IPS-D-TP-715 as required by the job.

6.2.2.7 Transformer/rectifiers shall not be installed in series or in parallel in the same cathodic protection circuit.

6.2.2.8 Transformer/rectifiers should be installed in non-hazardous area. If this is not possible, the construction of the rectifier units shall fulfill the requirements of the hazardous area classification applicable for the site.

Note:

When electrical work is carried out in hazardous areas requirement of IEC 79.14 shall be adhered to in conjunction with the area classification drawings and the following standards:

[IPS-E-EL-110/1](#) "Area Classification and Extent".

[IPS-E-EL-110/2](#) "Safe-Guarding in Hazardous Area".

6.2.2.9 If installed outdoors, the enclosure shall have a minimum degree of protection IP 54 in accordance with IEC 529.

6.2.2.10 Transformer/rectifier foundations shall contact tank support beams only.

6.2.2.11 Transformer/rectifier foundations shall allow space below the tank bottoms to permit painting.

6.2.2.12 If the proposed rectifier site is in an area where flooding may be a problem, the maximum high water level shall be ascertained and the transformer/rectifier mounted so that it will be above this level.

6.2.2.13 The transformer/rectifier shall be firmly secured to the plinth with holding down bolts to be supplied by the Contractor to the approval of the Engineer.

6.2.2.14 The transformer/rectifier manufacturer's instructions shall be followed completely.

6.2.2.15 The ac and dc cabling shall be installed through steel conduits to connect the transformer/rectifier as shown on drawings IPS-D-TP-701 & 715.

6.2.2.16 The ac current cables and dc current cables shall be placed in separate conduits.

6.2.2.17 After the installation of cables the ends of the steel conduit shall be fitted with a suitable blanking disc and coated with water proof sealing compound (plastic inserts shall be used in conduit ends to protect cables).

6.2.2.18 The electricity supply shall be taken from the nearest existing electricity pole or a new one to be installed and brought to a pole mounted electricity meter by under-ground cable. The T/R unit shall then be supplied from this meter (see IPS-D-TP-701 and IPS-D-TP-715).

6.2.2.19 Before connecting the supply to the unit, it shall be checked that it is the correct voltage as stated on the rating plate of the transformer/rectifier.

6.2.2.20 The connections of dc cables to the transformer/rectifier must be mechanically secure and electrically conductive. Before the transformer/rectifier is energized, it must be verified that the negative conductor is connected to the structure to be protected and the positive conductor is connected to the anodes at the power source output terminals.

Caution: The negative lead of the rectifier must be attached to the structure to be protected. If the structure is mistakenly attached to the positive lead, it will serve as an anode and rapid corrosion failure can result.

6.2.2.21 The transformer/rectifier shall be connected into either the existing earthing circuit or shall be separately earthed to a new earthing system according to design specifications. Typical installation of earthing system for cathodic protection station with fencing illustrated in standard drawing No. IPS-D-TP-717.

6.2.2.22 When the metal work of the transformer/rectifier unit is bonded to earthing terminal, precautions shall be taken to ensure that there is no possibility of metallic connection, even for a short period, between the earthing system and the groundbed of the cathodic protection installation.

6.2.2.23 After erection of a unit, it is important that the following be checked:

- a) Oil level is correct, if the unit is oil cooled.
- b) Fuse ratings are correct.
- c) Input and output cables are properly identified prior to connection to the electricity supply.

6.2.2.24 Transformer/rectifier(s) shall not be energized until all check-out and commissioning tests have been completed (see 11).

Note:

When electricity is connected, correct polarity and groundbed resistance should be verified by energizing the unit.

6.2.3 Cabling (see relevant IPS-D-TP Standard drawings)

6.2.3.1 All cabling shall be routed and installed in accordance with the design drawings and to the approval of the engineer.

Sufficient information is given in the design drawings to indicate the general routes of cables. Final route are to be determined on site and changes made only where absolutely necessary and with the approval of the Engineer.

6.2.3.2 Cables for connection between the transformer/rectifier and pipe and groundbed shall conform to the dimensions and characteristics indicated in the drawings and/or materials specifications (see IPS-M-TP-750: Part 7).

6.2.3.3 Cables run between the groundbed and transformer/rectifier and between the transformer/rectifier and structure(s) shall be continuous and free of splices.

6.2.3.4 To avoid kinks and knots, all cables shall be carefully unreeled and laid directly into the prepared trench. Where cables are reeled on drums, the drums shall be mounted on jacks.

6.2.3.5 Trenches shall be kept away from buried pipes containing hot fluids and from pipes liable to temperature rise owing to steaming out.

6.2.3.6 The bottom of the trench receiving direct buried cable shall be relatively smooth, undisturbed and well tamped earth. Care shall be taken to be sure that there are no sharp rocks or other objects in the cable trench bottom that could damage cable insulation.

6.2.3.7 Cables shall be laid with sufficient "Slack" to avoid breaking during or after backfilling and to allow for shifting and settling. When connection are made to pipe, the cable shall be wrapped around the pipe twice and taped down. Each wire terminated in the test box shall have at least 15 cm of slack coiled.

6.2.3.8 Cable runs under roads and areas subject to vehicular traffic shall be installed in steel or aluminum conduit of 20 mm minimum size.

The conduit used shall be reamed carefully after cutting to length to remove all sharp edges. Bushings shall be installed on both ends of the conduit.

6.2.3.9 The positive cable anode lead is especially critical to the operation of the system. It is imperative that insulation remain intact. Extreme care shall be taken to ensure that the entire cable and all connections are waterproof. Care shall be taken to ensure that there are no short circuits between the positive cable and the structure or conduit.

6.2.3.10 Cables shall enter the rectifier, groundbed test box and where applicable, other enclosures, in properly sized rigid conduit extending 450 mm below ground surface. Plastic inserts shall be used in conduit ends to protect cable.

6.2.3.11 Cables shall be installed as follows:

- Cables shall be laid in prepared trenches.
- Before cables are placed, the trench bottom shall be leveled and backfilled with a layer of soft sand 10 cm thickness.
- This soft sand shall be leveled and the cable placed thereon. The laying of cables shall be carefully done to avoid any damage to insulation. After laying and before covering, all cables shall be examined for cuts, nicks and any other damage. All damaged cables must be repaired before burying.
- The cable shall then be covered with a layer of fine sand 20 cm deep. The sand shall be lightly tamped. Machine compaction shall not be used.
- A protective covering warning device (bricks, tiles or red concrete slab) shall then be applied. The protective covering shall be placed without disturbing the sand fill while pouring.
- The remainder of the trench shall then be backfilled and compacted with soil such that existing elevations are met.

6.2.3.12 All cable main runs shall be tagged at each end with waterproof identification tags as per

cable schedules. Tagging method shall be approved by engineer prior to being carried out.

Color code of the cables shall be as follows:

- Between T/R and positive test box: Red
- Between T/R and negative test box: Black
- Between positive test box and groundbed: Red
- Between negative test box and structure: Black
- Between test point and pipeline: Black
- Between test point and casing: Red
- Between test point and foreign line: Red
- Between test point and insulating joint/flange: Red

6.2.3.13 All cable runs shall be identified with cable markers of the type shown in the IPS-D-TP Standard drawings, installed at fifty (50) meter intervals and turning points. Markers shall be installed at one edge of the trench.

The following information shall be marked on each marker plate, with a steel die stamp:

- Direction of cable runs.
- Location of trench with respect to marker.

Plates shall have a blank space approximately 15 mm x 50 mm for company's use.

Notes:

- 1) The distance between the top of a cable and the surface under which it is installed (depth of burial) shall be sufficient to protect the cable from damage imposed by expected surface usage.
- 2) The top surface of the cable in the trench shall be a minimum of 70 cm below finished grade.
- 3) Burial depth may be increased where necessary to meet underground conditions.
- 4) In areas where frost conditions could damage cables, greater burial depths than indicated above may be desirable.
- 5) Lesser depths than indicated above may be used in rocky terrains. The supplemental protection shall be provided. The supplemental protection should be sufficient to protect the cable from damage imposed by expected surface usage.
- 6) Where The surface is not to final grade, under which a cable is to be installed, the cable should be placed so as to meet or exceed the requirements indicated above, both at the time of installation and subsequent thereto.
- 7) The horizontal separation between direct buried cable and other underground structures shall be not less than 300 mm to permit access to and maintenance of either facility without damage to the other.
- 8) Where a cable crosses under another underground structure, the structure shall be suitably supported to prevent transfer of a harmful load onto the cable system.
- 9) Where a cable crosses over another underground structure, the cable shall be suitably supported to prevent transfer of a harmful load onto the structure.
- 10) Adequate support may be provided by installing the facilities with sufficient vertical separation.
- 11) Adequate vertical separation shall be maintained to permit access to and maintenance of either facility without damage to the other. A vertical separation of 300 mm is, in general, considered adequate but the parties involved may agree to a lesser separation in special cases.

12) Plowing in of cable in soil containing rock or other solid material shall be done in such a manner that the solid material will not damage the cable, either during the plowing operation or afterward.

13) The design of cable plowing equipment and the plowing-in operation shall be such that the cable will not be damaged by bending, side-wall pressure, or excessive cable tension.

14) At low temperatures some plastics are so brittle that they may crack when bending the cable, and therefore no cables shall be installed during freezing weather.

6.2.4 Electrical connections

6.2.4.1 Attaching cables

6.2.4.1.1 The thermit weld process (cad welding) should be used for attaching test leads, and bonding lead wires to structures.

6.2.4.1.2 Thermit welding process shall be such that copper penetration into the pipeline material shall not be deeper than 1 mm and that the hardness shall remain inside the original pipeline requirements.

6.2.4.1.3 Thermit welding shall not be used for austenitic stainless steel and duplex steel pipelines.

6.2.4.1.4 Thermit welding may not be used for structures contain or have contained flammable or combustible liquid.

6.2.4.1.5 Thermit welding process shall be applied in accordance with the requirements of Clause 13 and standard drawing No. IPS-D-TP-703.

Notes:

1) Connections of test lead wires to the structure must be installed so that they remain mechanically secure and electrically conductive. Care shall be exercised to ensure that cables and connections are not damaged during backfilling. Sufficient cable slack shall be provided to avoid strain.

2) All cable attachments to structures shall be coated with an electrically insulating material provided or approved by the Company. This coating shall be compatible with the structure coating and cable insulation, and have good adhesion to both.

3) The following welding process, as an alternative to thermit welding, for the cable connections may be required:

3.1 Welding

A metal plate, 50 × 50 mm minimum, provided with a welded M 10 threaded stud bolt, shall be welded to the pipeline by two continuous welds in the circumferential direction of the pipe only. The plate shall be made of the same material as the pipeline.

The cables shall be connected to the threaded studbolt using crimped or brazed cable lugs, nuts and serrated washers.

3.2 Stud welding

Stud welding may be done using an electrical (resistance welding) or mechanical (friction welding) process which shall be approved by the Company.

The stud material and consumables shall be compatible with the pipeline material. The process shall not influence the pipeline material properties to fall outside the original specifications.

The size of threaded studs shall be 8 mm or more to suit the cable size. The cables shall be connected to the stud using crimped or brazed cable lugs, nuts and serrated washers.

3.3 Pinbrazing

The pinbrazing process shall use specially designed cable lugs and brazing pins to braze the cables to the pipeline and shall be approved by the Company.

The brazing materials shall be compatible with the pipeline material. Penetration of copper and/or other brazing metals into the pipeline shall not be deeper than 1 mm and the hardness shall remain inside the original pipeline requirements.

Pinbrazing shall not be used on austenitic stainless steel and duplex stainless steel pipelines.

3.4 Glued connections

Where welding, brazing or thermit welding is not possible, e.g. for safety reasons, the contractor may design glued electrical connections using metal plates bonded with electrically conductive epoxy resin. This method shall not be used for current carrying cables (drain cables, bond cables). The materials to be used and the installation procedure shall be approved by the Company.

6.2.4.2 Splicing cables (see IPS-D-TP-719)

6.2.4.2.1 Cable splicing plays a very important role to a good cathodic protection system. Cable splices shall be properly insulated to preclude current leak.

6.2.4.2.2 Anode lead wire to header cable connections and header cable splices shall be made by using a split bolt connector (line tap). An epoxy resin splicing kit shall then be applied over the tightened zero resistance connection in accordance with the manufacturer's recommendations, 6.2.4.3 and standard drawing No. IPS-D-TP-719.

Notes:

- 1) For good insulation result, manufacturer's instruction for epoxy resin splicing kit installation shall be rigidly followed.
- 2) The resin shall not have exceeded its specified shelf life.
- 3) Buried connections must be protected with extreme precautions against the entrance of any moisture, for any discharge of current to earth from the cable will destroy it in a matter of days or hours.
- 4) Proper cleaning (degreasing and abrading) of the insulation is necessary to ensure that a watertight bond is achieved between the insulation and the cable-jointing compound. Where repairs are carried out, a minimum of 50 mm of cable insulation, on each side of the repair, shall be contained within the repair.
- 5) Random checks shall be made during installation of joints in accordance with the manufacturer's instructions. Where applicable, these checks should ensure that:
 - The joint area is dry;
 - The resin compound has not overrun its expiry date;
 - Sheath abrasion, if specified, is properly carried out;
 - The connector stagger and other dimensions are observed;
 - The preparation, installation and tightening of conductor connectors is correct;
 - The appropriate tools, particularly for compression connectors are used by the installer;
 - The cable is laid straight and the box and cable are well supported so that movement during pouring encapsulant is not likely;

- The cold pour encapsulant is thoroughly mixed;
- The encapsulant fills the mold and does not distort its shape significantly;

The electrical testing of the installation is deemed to be completed by final system installation/commissioning tests.

6.2.4.3 Cable jointing procedure

6.2.4.3.1 General

- a) The instructions and procedures given in this Clause should be observed at all times during the preparation and installation of a cable joint.
- b) Joint kits should be inspected before use and any defect made good.
- c) When using resin compounds good housekeeping practices should at all times be observed in accordance with manufacturer's instructions. The following precautions should be taken when handling jointing materials used in the preparation of cable joints.
 - Do not use in a confined unventilated area.
 - Avoid breathing the vapors.
 - Wear protective clothing at all times when handling cold pour resins.
 - Avoid contact with the skin and eyes.

Note:

In case of accidental contact with skin, treat the affected area with copious quantities of water (or with the reaction agent recommended by the resin manufacturer). For eyes, follow the same treatment and immediately obtain medical aid.

- Containers of resin compounds should be kept closed at all times except when actually in use.
 - Smoking should be prohibited.
 - Accidental spillage should be cleared immediately.
 - After use, all containers should be disposed of strictly in accordance with the manufacturer's instructions.
- d) The following equipment may be required for use:
 - A basic jointer's tool kit including consumable materials;
 - A tent or some effective means of protecting the jointing operations from moisture, rain or excessive cold or heat;
 - Those tools supplied or recommended by the splicing kit manufacturer, e.g. compression tools;
 - Special equipment, e.g. fire extinguishers and pumps.
 - e) The equipment used in making cable joints should be regularly maintained in accordance with the manufacturer's instructions.
 - f) At all times, every effort should be made to ensure dirt does not become entrapped in a joint. Tools should be laid out in an orderly manner and when not in use replaced in their chosen place. Waste products, e.g. trimmings from sheaths or insulation, should be placed in a receptacle provided for the purpose.

6.2.4.3.2 Jointing application

- a) Before starting the joint, the jointer shall ensure that all the correct materials are available.
- b) The cables to be joined should be lined up approximately in the position required for the joint.
- c) The outer covering(s) of the cable(s) should be removed to the dimensions given in the jointing instructions; followed by removal of other cable materials to expose cores. The core insulation(s) should then be removed or partly removed over sufficient lengths to take the

connectors.

d) PVC sheaths should be removed with a sharp knife or special tool designed for the purpose, by making a circumferential cut for cable ends or tow cuts at joint positions, plus one longitudinal cut. The circumferential cut(s) is made first and the PVC is cut through about two-thirds of its thickness to avoid damaging the cable component below the sheath. The longitudinal cut is then made with the knife blade almost tangential to the cable. The PVC sheath is completely penetrated when making this cut. The sheath can then be removed by tearing it away at the circumferential cut(s).

e) Polymeric insulation should be removed with a knife, care being taken not to damage the conductor.

Note:

Polymeric material is easily cut when slightly warm, but care should be taken not to overheat.

f) The conductors and connectors should be cleaned before the connections are made. It is important that the cleaning of conductors should be strictly in accordance with the manufacturer's instructions.

g) Mechanical connectors should be tightened in accordance with the manufacturer's instructions.

h) The joint mold should be presented to the joint to ensure adequate clearances. When satisfactory, secure the mold and fill with encapsulating compound where appropriate.

Note:

In low temperature conditions, cold pour compounds can be harder to mix and will have longer curing times. Every effort should be made to store the compound at an ambient temperature above 5°C, and at all times the manufacturer's storage instructions should be observed.

6.2.5 Installation of test stations (test points)

6.2.5.1 The contractor shall install the cathodic protection test points which shall be as indicated in the Standard drawings (see IPS-D-TP-710 & 716). The contractor shall supply the necessary materials for installation of test point when required by the Company.

6.2.5.2 The contractor shall install cathodic protection test points at locations specified in the design drawings. Precise location of test point connections to the structure shall be subject to the engineer's approval prior to their attachment.

6.2.5.3 Unless specified otherwise by the Company, cathodic protection test facilities shall be installed at distances of maximum 1000 m along the pipeline and at 250 to 300 meters in urban or industrial areas and, in addition, at all foreign pipeline crossings, insulating flanges/joints, cased crossings, both sides of river crossings and at any location where interference with other buried installations is found at the time of starting-up of the cathodic protection system in accordance with the design drawings.

Care shall be exercised to avoid damage to structure coating during excavation and backfill.

6.2.5.4 If pipelines are running in parallel, but not in the same trench, each pipeline shall be provided with separate potential monitoring facilities. Test points shall be installed not more than 2.5 m away from the pipeline.

6.2.5.5 Cables necessary for the connections between structure and test point shall be as specified in the design drawings. Cables shall be laid on padding of soft earth at least ten (10) centimeters thick in trench at least 0.80 meters deep and shall be covered with at least fifteen (15) centimeters of soft earth. Cables shall be so placed that they will not be subject to excessive strain and damage during backfill operation. All test point cables shall be installed with sufficient slack.

6.2.5.6 The structure and test lead wires shall be clean, dry, and free of foreign materials at points of connection when the connections are made. Connections of test lead wires to the structure must

be installed so that they will remain mechanically secure and electrically conductive.

6.2.5.7 The test lead connections shall be properly bonded to the structure by thermit-welding process.

6.2.5.8 The thermit-weld on the structure shall be made after installation of the structure. In any case, the contractor shall ensure that the cables are maintained intact. Splicing of the cable shall not be permitted.

6.2.5.9 All test lead wire attachments and all bared test lead wires shall be coated with an electrically insulating material. If the structure is coated, the insulating material shall be compatible with the structures coating and wire insulation.

6.2.5.10 Conductor connections at bonds to other structures or across insulating joints shall be mechanically secure, electrically conductive, and suitably coated. Bond connections shall be accessible for testing.

6.2.5.11 Cathodic protection test points attached to the structure shall be tested for electrical continuity between structure and test connection, prior to commissioning of the cathodic protection system. Any cable not passing the final tests shall be replaced.

6.2.5.12 All test point cable leads shall be color-coded or otherwise fitted with identification tags adjacent to the cable lug. Damage to wire insulation shall be avoided. Test leads shall not be exposed to excessive heat and sunlight.

6.2.5.13 Each test point shall be clearly labeled and/or marked with a specific number as follows:

- For above ground test points by stamping a plate attached to the test point.
- For grade level test points, marker plates shall be installed on the nearest adjacent building or wall in built up areas.

6.2.5.14 Types of test points

Type A - Single test points

a) Above ground test points for desert or rural area installation. This type shall be installed along the main branch and/or cross country lines in accordances with standard drawing No. IPS-D-TP-710. It utilizes a combined line marker and a terminal box with screw-on cover with test wire coiled and left in the box through conduit with their ends taped to avoid contact.

b) Grade level test points for urban area installation. This type shall be installed in sight-holes (embed into the ground) in the pipeline axis, off limits of road crossings in accordance with standard drawing No. IPS-D-TP-712. It utilizes a street sight-hole with cover with test wires coiled and left in the terminal board. Ample wire slack shall be left in the housing below the terminal panel to allow for backfill settlement and for withdrawing the terminal panel.

Type B - Crossings and parallelism with existing pipelines

This type will consist of two separate cables attached to each individual pipeline, terminating in a test box (type 1) with suitable facilities to install direct or resistive bonds. The cables to each pipeline shall be identified by color coding or tags.

Type C - Casing test point

This type shall be installed in accordance with standard drawing No. IPS-D-TP-716. It utilizes a combined line marker and a terminal box with screw-on cover with test wires coiled and left in the box through conduit with their ends taped to avoid contact and clearly labeled.

If the casing is longer than 30 meters, the test point shall be installed at both ends of the casing. Shorter casings shall be provided with a test point at one end only.

In each test point, one test cable shall be connected to the pipeline and, one test cable shall be connected to the casing. Both cables shall be terminated in test point.

Type D - Insulating joint/flange test point

This type shall be installed across each insulating joint/flange in easily accessible locations. Two

cables shall be connected to each side of the joint or flange. All cables shall be separately terminated in common test box (type 1) with suitable facilities to install direct or resistive bonds. The cables to each side of the insulating joint/flange shall be identified by color coding or tags.

Type E - Line current measurement test point

This type shall consist of two pairs of cables, each pair connected to the pipeline 30 to 60 meters apart. All cables shall be separately terminated in common test box (type 1) with suitable facilities. The cables shall be identified by color coding or tags.

6.2.6 Installation of insulating devices

The contractor shall align, install and test all insulating devices shown in the design drawings in accordance with requirements of Clause 12.

6.2.7 Installation of test box(es)

The test box(es) internally equipped with copper bus bar, copper links, copper terminals and a proper rotary resistor shall be installed for the following purposes:

- a) Connection of anodic cables (header cable and positive cable) between grounded and positive pole of transformer/ rectifier, and control of the grounded current through the rotary resistor circuit (as positive test box).
- b) Connection of cathodic cables (negative cables) between structure and negative pole of transformer/rectifier, and control of the cathodic protection system (as negative test box).
- c) Bonding between different cathodic circuits.

The box(es) shall be installed in accordance with standard drawings Nos. IPS-D-TP-702 and IPS-D-TP-704.

6.2.8 Earthing of CP equipment

6.2.8.1 The object of electrical earthing is to ensure effective operation of the transformer/rectifier in the event of earth fault current, that might otherwise cause damage to property, and protect against danger to life through shock due to installation metal work being maintained at a dangerous potential relative to earth.

6.2.8.2 Local earthing circuit shall be installed at the CP station(s), in accordance with 6.2.8.3 and as detailed on the standard drawing No. IPS-D-TP-717.

Each earthing system will be composed of:

- Earthing pits for connection and inspection of the copper rods.
- Copper rods inserted in the earth.
- Bonding header cables between the pits.
- Earthing cables from header cable to CP equipment and fence.

6.2.8.3 The requirements for the connection of metalworks of CP station(s) are specified in:

BS 7430 (1991)	"Code of Practice for Earthing"
Formerly C.P. 1013 (1956)	
BS 6651 (1985)	"Code of Practice for Protection of Structures Against Lightning"
IPS-E-EL-100/1	"Earthing, Bonding and Lightning Protection"

Notes:

- 1) Earthing shall be installed fully underground.
- 2) Earthing should be carried out at locations where the soil resistance is the lowest. Sandy soil should be avoided.
- 3) The grounding resistance should be kept as low as possible by adding salt, coke or any other kind of backfilling.

6.2.8.4 If CP station(s) to be installed inside the area with individual earthing system, such as compressor station, valve station, city gate station, etc. The CP equipment shall be adequately bonded together and connected to the existing earthing system.

6.2.8.5 In absence of earthing drawings, CP equipment shall be adequately bonded together and connected to the earth electrodes.

6.2.9 Fencing

6.2.9.1 Installation of fencing shall be as follows:

- For transmission pipelines according to IPS-D-TP-709.
- For in-plant and distribution networks that is inside the cities, according to IPS-D-TP-718.

6.2.9.2 Erection of fencing shall be performed by competent workmen, experienced in industrial type fence erection.

6.2.9.3 Contractor shall be responsible for the supply of all material, tools and equipment necessary to carry out the work.

6.2.9.4 Particular care shall be exercised during fence erection so that no underground piping, cable or other appurtenances are touched or damaged.

6.2.9.5 On completion of work, all excess and waste materials resulting from fence construction shall be removed from the site by the contractor.

6.2.10 Parallel power lines

If the pipeline runs in the vicinity of high voltage power lines, the contractor shall investigate whether high ac voltages can be present on the pipeline by induction or otherwise and whether devices have to be installed for protection of the pipeline and personnel.

The contractor shall show (by calculation or otherwise) that no harmful voltages can be present or design additional facilities to prevent excessive voltages. Such facilities may consist of dedicated pipeline earthing and/or the installation of polarization cells or surge arrestors across isolating joints/flanges and across the output terminals of dc voltage sources.

6.2.11 Lightning protection

In areas of lightning activity the contractor shall install suitable lightning protection to protect the pipeline isolation and cathodic protection equipment. This should consist of suitably rated surge arrestors. Surge arrestors shall be mounted across isolating joints/flanges and across the output terminals of dc voltage sources.

6.2.12 Surge arrestors

Surge arrestors required to prevent elevated voltages due to faults in adjacent electrical power systems or lightning shall be of the spark gap type and shall be such that :

- The impulse breakdown voltage of the electrodes is lower than that of the isolating joint across which they are mounted;
- The spark gap is capable of discharging the expected lightning currents without sustaining damage;
- The spark gaps are fully encapsulated to prevent sparks in open atmosphere and to protect the spark gaps from moisture.

6.3 Installation of Galvanic Anode Systems

Anodes shall be installed according to design specifications and drawings. Before anode is buried, it is important that any waterproof wrapping material be removed. Typical galvanic anode installations shall be of the following types:

6.3.1 Single packaged anode ([IPS-M-TP-750](#): Part 3)

6.3.1.1 Anodes shall be installed at a minimum distance of 1.5 meter from the pipeline and at least 30 centimeters (1 ft) deeper than the pipeline.

6.3.1.2 The native earth shall be thoroughly tamped around the anode, watered, then backfilled to the surface (After making all anode lead connections and insulating them).

6.3.1.3 Anodes shall be placed 2 meters away from any secondary buried structure and so that the secondary structure does not lie between the anode and the primary structure.

6.3.1.4 In distribution systems, where space limitations are extremely critical and where soil resistivities and auguring conditions permit, anodes shall be placed in auger holes alongside the pipe with the hole being deep enough that reasonable spacing between pipe and anode is obtained.

6.3.2 Multiple galvanic anodes

6.3.2.1 In multiple galvanic installation, the anodes shall be placed in straight line configuration for lowest resistance to earth. The line of anodes may be either perpendicular to the pipeline, or may be along a line parallel to the pipe as per IPS-D-TP-711.

6.3.2.2 A Parallel line of magnesium anodes shall be about 5 meters away from the pipeline, with zinc, this distance shall be about 3 meters for optimum performance.

6.3.2.3 Where anodes and backfill are provided separately, anodes shall be centered in the backfill and the backfill shall be compacted before any additional backfill soil is added. The backfill shall be thoroughly wetted before burial is completed.

6.3.2.4 The connection to the pipe shall be made before more than one anode is installed; it will then be possible to observe the current output of successive anodes as they are connected, and installation shall be halted before the average output per anode falls below 150% of the designed value.

6.3.2.5 One 0.01 ohm measuring shunts shall be installed, in each lead wire, current limiting resistors is not permitted.

6.3.2.6 The anodes thus installed shall be permitted to operate unrestricted for a period of three weeks or more. This will permit adequate polarization and stabilization of current output. After this time, a current output and pipe-to-soil potential survey shall be made. Resistors shall be installed where needed and the current reduced to the designed value. It is particularly important to check the potential at the midpoints between stations (if they are unequal in size, then at the low point). If these potentials should all be found above 0.85, then the installation is complete.

6.3.3 Extruded ribbon anodes

6.3.3.1 Extruded ribbon anodes (of either magnesium or zinc), shall be plowed-in parallel to the pipeline along sections of bare or poorly coated line where continuous local protection is required.

6.3.3.2 Magnesium ribbon anodes shall be installed in accordance with IPS-D-TP-714.

6.3.3.3 Connections between the pipeline and anode core wire shall be made at intervals to complete the protection circuit. The cross connections shall be made at test points at convenient location, to measure current flow periodically and estimate the rate of anode material consumption. Intervals between cross connections shall not exceed 300 meters.

6.3.3.4 Spacing between the ribbon anode and pipeline is not critical. To remain clear of the pipe during plowing-in operations, a spacing of 1.5 meters may be used.

6.3.3.5 The anode strip shall be deep enough to be in continuously moist soil (at least 0.6 meter).

6.3.3.6 Extruded ribbon anodes of magnesium (or zinc) are furnished bare. Using anodes in earth

without a special backfill involves risk of anode passivation and inadequate amounts of current. The anodes shall be plowed-in with suitable special backfill according to design specification. An adequate allowance for satisfactory dispersion around the anode, is 32 kg of backfill per 30 meter (100 ft) of ribbon anode.

6.3.4 Connection of galvanic anodes to pipeline

6.3.4.1 The anodes shall be connected to pipeline using the combined marker, test point and bondbox. This equipment shall be made according to DWG. No. IPS-D-TP-712 and installed as shown on DWG. No. IPS-D-TP-711 for the following purposes:

- Pipe to anodes groundbed connection;
- Pipe-to-soil potential measurement;
- Installation of a rotary resistor between anodes and pipeline to allow the anode current control;
- Marking the location of anodes.

6.3.4.2 Anode lead wire shall be connected to a loop shaped cable (called header cable), using suitably sized split bolt (line tap) or compression type connectors and a proper branch type (3 way) splicing kit. Splicing compound shall be applied over the tightened zero resistance connection (see 6.4.2).

6.3.4.3 The coated splice shall be insulated by taping with at least one half-lapped layer of rubber tape and one half-lapped layer of electrical insulating tape (see [IPS-M-TP-750](#): Part 13), with the joint insulation overlapping the wire insulation a minimum of 50 mm.

6.3.4.4 The current carrying cable composed of two sections in black color. One section will connect the header cable to terminal No. 1 of "Combined Marker, Test Point and Bondbox", the other section connects pipeline to terminal No. 2.

6.3.4.5 A test wire shall be connected between pipeline and terminal No. 3 at "Combined Marker, Test Point and Bondbox".

6.3.4.6 Thermit welding (cad welding process) shall be used to connect the anode lead wire to the pipeline.

6.3.4.7 The copper wire connection to the steel main is the most critical insofar as insulation is concerned. At this point, all copper at the connection must be coated completely to avoid the possibility of a shielded copper-steel corrosion cell.

6.3.4.8 All connections must be permanently low resistance. Any gradual development of joint resistance can reduce anode output

6.3.4.9 Insulation of underground connections on galvanic anode installations shall be well done to prevent current wastage. The connection shall be waterproofed completely to prevent possible development of resistance within the joint.

6.3.4.10 Care shall be taken so that lead wires and connections are not damaged during backfill operations. Lead wires shall have enough slack to prevent strain. Anodes shall not be carried or lowered into the excavation by the lead wire.

Notes:

1) The chemical backfill in packaged galvanic anodes will take up moisture slowly even if wet down with water after placing in the auger hole and before completing the earth fill. For this reason, the anode will not attain full output immediately. Depending on the amount of moisture in the earth, it may be a matter of days or even weeks before full output is attained.

2) When bare galvanic anodes are placed in auger holes and backfilled with separate chemical backfill, it is the usual practice to install the backfill dry. There will be a time lag before full current output is attained as in the case with packaged anodes. It is possible to mix the chemical backfill with water and pour the slurry into the auger hole to surround the

anode. Full output will be attained immediately. There is, however, danger of shrinkage as the excess water leaves the slurry. This shrinkage may operate to cause ultimate reduction in current output. Backfill installed dry, on the other hand, tends to swell upon taking up moisture developing maximum coupling between the anode and the surrounding earth. For this reason, the use of dry backfill is considered the best practice.

7. INSTALLATION OF CP SYSTEMS FOR COMPACT BURIED STRUCTURES

7.1 General

7.1.1 This Clause 7 outlines procedures for the installation of cathodic protection systems for the of external surfaces of compact buried structures, including tank farms, service station tanks, tower footings, steel pilings (in soil), short well casings, compressor and pump stations, refineries, petrochemical plants and associated pipework.

7.1.2 The installation of cathodic protection systems for compact buried structures is basically similar to the installation of buried pipelines, so, many of the requirements outlined in Clause 6 in respect of buried pipelines are applicable to compact buried structures, with the following exceptions:

- a) Before any work is carried out on or near an insulated flange, the area shall be checked for hazardous atmospheres.
- b) To avoid risk of electric shock and the possibility of sparking, it is advisable that insulating joints be crossbonded before being disassembled. This precaution is essential for hydrocarbon product lines.
- c) Galvanic anodes shall preferably be sited on a line normal to the long axis of the tanks at a distance of about 5 m from the outside surface of the tank; if two anodes are used one shall be positioned on each side of the tank. For a well-coated tank the siting of the anodes is not critical, and they may be sited to suit conditions, at a distance of approximately 3-6 m from the tank.

The anodes shall be buried at a depth which places them in permanently moist soil if possible.

The lifting lugs situated at either end of the tank provide convenient points of attachment for anode cables. The lugs shall be scraped carefully to expose the bare metal, and the cable end attached by bulldog clamp or by thermit welding; the coating shall then be made good.

For tanks which are already buried, the cable can be connected to the vent pipe.

The cables from the tanks shall preferably be connected to the cables from the anodes via a test box, including a measuring wire from the tank to enable periodic checks of the steel-to-soil potential to be made, as well as current measurements of the anodes.

d) Impressed current groundbeds shall be arranged symmetrically around a tank or group of tanks. Dependent upon the space available, the groundbeds shall be located not less than one tank diameter from the tank periphery to provide optimum current distribution over the tank bottom. If this is not possible, consideration shall be given to distributing a number of anodes or groundbeds evenly around the periphery of the tank or to installing borehole groundbeds. The top anode of a borehole groundbed shall be at a minimum depth of 10 m to facilitate current distribution.

If flammable liquids are being stored in the tanks, the preferred siting of the groundbeds is outside of the bund walls. Where this is not possible, the groundbeds and all connections shall either be totally buried or, if above ground, comply with the requirements of the electrical classification of the hazardous area (see [IPS-E-EL-110/1](#)). This shall also apply to any negative drain point connection to the tank. If borehole groundbeds are used, any steel casing shall be finished below ground level to ensure that any spark hazard due to inadvertent contact between the casing and protected steelwork cannot occur.

7.2 Structure Preparation (to be Considered by Structural Constructor)

7.2.1 The tank foundation mound shall as far as possible be constructed so that it will distribute protection current uniformly to the whole of the underside of the tank. This means that the use of rubble, rock fill, etc., shall be avoided and the mound shall consist of fine-grained and well compacted material, to a minimum depth of 150 mm.

7.2.2 Storage tank bottoms are generally constructed by lap welding individual plates and are therefore electrically continuous. Where groups of tanks are to be cathodically protected, provision shall be made for bonding between individual tanks.

7.2.3 If it is desired to confine the protection current to the tanks, isolating joints shall be installed in all pipelines and fittings connected to the tanks including electrical and instrumentation connections.

7.2.4 If flammable liquids are being stored, such joints shall be located outside the tank bund. Earthing electrodes connected to the tank shall be of zinc, or stainless or galvanized steel.

7.3 Installation of Permanent Reference Electrodes (to be Considered by Structural Constructor)

7.3.1 If the installation of the metallic structure is likely to obstruct correct electrode placement, permanent reference electrodes shall be installed immediately prior to construction. For large structures, consideration shall be given to installation of reference electrodes and associated cabling prior to the laying of foundations. Cabling shall be laid with sufficient free play to allow for foundation movement and structural loading.

7.3.2 Reference electrodes shall be installed as close as possible to the buried structure without touching or shielding the surface. The backfill around the electrode shall have a resistivity no greater than that of the soil surrounding the buried structure. Allowance shall be made for foundation settling when locating reference electrodes.

7.3.3 Where reinforced concrete foundations are to be laid, care shall be taken to ensure that all reference and test point cabling and equipment are electrically isolated from metallic reinforcement materials.

7.3.4 Reference electrodes, associated cabling and connections shall all be checked for damage prior to installation. Correct operation and electrical isolation of the system shall be confirmed prior to final reinstatement of backfill material.

7.3.5 The actual location of permanent reference electrodes and cabling shall be accurately documented on the as-built drawings.

7.4 Installation of Insulating Flanges, Joints and Couplings

7.4.1 All insulating flanges, joints and couplings shall be installed in accordance with the requirements outlined in Clause 12.

7.4.2 The assembly of an insulating flange requires particular care, to ensure that insulation is not lost due to mechanical failure of the components.

Note:

The use of resistance methods to determine the integrity of insulating flanges in the field can produce unreliable results.

7.4.3 Completed flanges shall be coated in accordance with design specifications and/or [IPS-E-TP-270](#).

7.4.4 Insulating joints shall be checked for insulation integrity by measurement of structure-to-soil potential on each side of the joint, with the reference electrode in the same location. Different potential readings indicate adequate insulation. If the potential readings are the same, a cathodic protection current (or changed cathodic protection current) shall be applied to one side of the joint, and the potential remeasured. If the potentials remain the same on both sides, the joint is not adequately insulating.

8. INSTALLATION OF CP SYSTEMS FOR INTERNAL SURFACES

8.1 General

8.1.1 This Clause 8 outlines procedures for the installation of CP systems for internal surfaces of pipes and structures such as heat exchangers, hot water systems, clarifiers, ballast and storage tanks, cooling conduits and reservoirs, that are in contact with prude and natural waters including seawater and waters of near neutral pH.

8.1.2 Full construction detail and installation procedures of the CP system for each specific type of structure will be specified in design specification and drawings.

8.1.3 Many of the requirements outlined in Clause 6 in respect of buried pipelines are applicable to internal surfaces.

8.1.4 The installer shall be thoroughly familiar with the specifications for the works, and shall ensure that all works are completed in accordance with good industrial practice and the relevant specifications. Departures from design specifications shall be approved by the designer and/or Company and permanently recorded for future reference.

8.1.5 Care shall be exercised to ensure that cables and other components are protected from damage during installation. All cable connections need to provide reliable long-term low-resistance electrical contact.

8.2 Materials and Equipment Acceptance (or Compliance)

8.2.1 See Sub-clause 5.5.

8.2.2 Impressed current anodes shall be provided with individual lead wires to the rectifier for control and measurement of current output from each individual anode.

8.2.3 Because anode cables may be subject to attack from a high chlorine environment found near some anodes, it is important that the cable insulation and sheathing be resistant to such an environment, or otherwise be suitably oversheathed or protected (see [IPS-M-TP-750](#): Part 7).

8.3 Installation of Impressed Current Systems

8.3.1 Impressed current anodes shall be installed in accordance with design specification and drawings. Anods must be spesed to distribute current uniformly.

8.3.2 Impressed current anodes shall not be directly attached to the internal part of the structure. They are required to be insulated from the structure and, in all cases, the electrical connection is to the positive terminal of the dc power source.

8.3.3 Because anodes are often brittle or have thin film electrodeposited coatings, (mmo) care shall be exercised to ensure that they are not damaged during handling.

8.3.4 Certain anodes are specifically designed for suspension by their cable tails, and may be lowered into position by the cable. Other anodes generally of the direct immersion type, may require to be lowered into position by separate ropes, as their cable tails are designed for electrical purposes only and not for mechanical suspension. The installation drawings shall be checked before commencement of anode installation.

Notes:

1) Anodes which are in close proximity to a coated steel structure shall be provided with an adequate dielectric shield, designed so that the potential at the periphery of the shield does not exceed -1.2 Volts (on) with reference to a copper/copper sulfate electrode.

2) In the case of cantilever anodes, which are generally rod-shaped and project from the structure, obstruction of the active anode surface can be avoided by using an adequate shroud length to prevent build-up of a calcareous deposit on the structure surface.

3) For safety reasons, suspended anodes, other than light anodes of platinized titanium or mixed metal oxides which are specifically designed to be suspended by their cable tails, shall be supported by a suitable rope of polypropylene (see [IPS-M-TP-750](#): Part 10), to prevent the anode cable bearing the anode weight.

8.3.5 Cable supports shall be corrosion resistant and located so that the cable insulation does not become abraded due to cable movement from wind or electrolyte forces. Cable routes shall also avoid areas of likely damage from physical operations on the structure.

8.3.6 Cable joints shall be completely waterproofed using an appropriate cable-jointing compound (see [IPS-M-TP-750](#): Part 11). Waterproofing is particularly important on the positive side of an impressed current system to prevent localized rapid corrosion and subsequent failure of the corrosion protection system (see [IPS-D-TP-719](#)).

Note:

Proper cleaning (degreasing and abrading) of the insulation is necessary to ensure that a watertight bond is achieved between the insulation and the cable-jointing compound. Where repairs are carried out, a minimum of 50 mm of cable insulation shall be applied to each side of the repaired cable joint.

8.3.7 Anode to cable tail encapsulation for immersed anodes is generally fitted at the factory. Prior to installation the encapsulation shall be carefully inspected for any faults or handling damage during transit.

8.3.8 Anodes which project from support pipes or require centering through insulating sleeves may require inspection after installation.

Note:

Of special importance to be inspected during the installation is to ensure that the anode material and size are in accordance with relevant parts of [IPS-M-TP-750](#), where applicable and/or to the approved specifications.

WARNING:

Where underwater diving inspection or maintenance is likely, structures shall have warning notices displayed advising of the danger of electrical gradients near the anodes and the need to switch off the system prior to diving.

CAUTION:

Signs shall be displayed indicating the presence of any immersed cables or anode support ropes which are not physically protected.

8.3.9 Anodes and their support cables on structures located in flowing fluids shall be designed to withstand vibration and impact.

8.3.10 Requirements of this Standard and local authorities shall be observed during the installation

of a transformer/-rectifier especially with regard to ac input, cabling, and positioning.

After installation of a unit, it is important that the following be checked:

- a) The input and output terminals are correctly identified, and the structure cable is connected to the negative output terminal prior to connection to the electricity supply.

Note:

When electricity is connected, correct polarity and loop resistance shall be verified by energizing the unit, and checking that the structure potential is shifted in the negative direction.

- b) The oil level is correct (if the unit is oil-cooled).
- c) The fuse ratings are correct.

8.3.11 Safety precautions

Precautions must be taken to:

- a) The effects of lightning, both on the protected structure and via the electricity distribution system (personnel protection aspects shall also be included).
- b) Electrical gradients resulting from impressed current systems occurring in water around fully and partially submerged anodes and in waterways adjacent to anode installations.

Note:

Paralysis and respiratory failure may result if a person comes in contact with electric field strengths greater than 3 V/m in water. Should the design result in a possible electric field strength exceeding this value in waters located close to impressed current anodes, warnings should be given and access to such areas prevented by shielding or by other means.

- c) Avoid sparks in the presence of flammable substances and explosive gas mixtures that may be present around oil treating vessels.
- d) The cable to anode connections in impressed current systems shall never be disconnected, nor shall the anode be removed while the rectifier is in operation.
- e) Usual precautions to prevent fire or explosion must be taken before a cathodic protection system can be installed or repaired in a vessel handling water mixed with oil or gas.
- f) The rectifier case, external ac disconnect switch box, and any related metallic equipment must be properly grounded using recognized safe grounding practices.
- g) Special gaskets capable of withstanding high temperatures shall be used to mount anodes in fired vessels, particularly if the gaskets are located near the fire tubes.

8.4 Installation of Galvanic Anode Systems

8.4.1 Anodes shall be installed according to design specification and drawings.

8.4.2 The common methods of installation of galvanic anodes are as follows:

- a) By direct attachment to the internal part of the structure; or
- b) By suspension in the electrolyte from the structure using a cable or a rigid metal support; the cable is connected to the structure above electrolyte.

Note:

For safety reasons, suspended anodes shall be supported by a suitable rope of polypropylene (see [IPS-M-TP-750](#): Part 10) to prevent the anode cable bearing the anode weight.

8.4.3 Anodes which are to be installed flush with the structure may be attached to the structure by either of the following methods:

- a) Welding of the anode core to the structure.
- b) The use of structure studs nuts to attach the anode core.

8.4.4 In all cases, the anode shall be in reliable long-term low-resistance metallic contact with the structure. This may be achieved by the use of fusion joints, bolted connections, or by direct screwing into the structure surface. Ensure that corrosion resistant materials are used and the joints are effectively insulated (wrapped).

8.4.5 Before immersion of the anodes, it is necessary to remove any material wrapped around them. The anodes shall not be painted and, where necessary, shall be protected from accidental paint application.

CAUTION:

The adequate support of anodes is necessary to avoid possible cable failure.

8.5 Permanently-Installed Reference Electrodes

8.5.1 If permanent reference electrodes are installed for the measurement of the structure-to-electrolyte potential, it is important that they are continually immersed when in use.

8.5.2 Reference electrodes shall be located in accordance with the design requirements. Each reference cell shall be wired to a termination position by a separate and isolated conductor, insulated from the structure and the electrolyte and protected by continuous conduit. The separate conductors can be installed together using multicore cable.

8.5.3 It is essential that reference cell wiring is electrically shielded between the structure exit point and the termination position.

8.5.4 The most convenient method of mounting reference electrodes inside plant is by means of a "screw-in" assembly such that the electrode can easily be withdrawn for inspection and replacement of either the entire unit or the electrode material. The electrodes can be wired to central monitoring and control equipment. A disadvantage lies in the difficulty of checking the accuracy of the electrodes, once installed.

8.5.5 If it is impossible to use 'screw-in' mountings, reference electrodes can be attached by suitable non-metallic fixings to the protected surface and the insulated connecting leads brought out through the plant wall through a suitable gland.

8.5.6 At least one reference electrode shall be installed for each cathodically protected compartment. The reference electrode shall be installed at the position where corrosion is most likely, e.g. at junctions of ferrous and non-ferrous materials and/or remote from anodes.

Notes:

1) Care must be taken in placing the reference electrode in the treating vessel. For potential measurements the electrode must be as far from the anodes as possible. In the pressure vessels, the electrode is "Lubricated" (introduced into the vessel against existing vessel pressure) through a gate valve installed in the vessel for that purpose.

2) Contamination of the reference electrode with oil or sediments such as iron sulfide must

be avoided. A salt bridge may be used to prevent contamination of the reference electrode.

3) Location of the reference cell near an anode may indicate a higher potential than elsewhere in the vessel.

9. INSTALLATION OF CP SYSTEMS FOR MARINE STRUCTURES

9.1 General

9.1.1 This Clause 9 specifies general construction requirements for the installation of cathodic protection systems that will control corrosion of the submerged zones of marine structures and the buried parts of integral offshore/onshore structures.

Full construction details and installation procedures of the CP system for each specific type of marine structure will be specified in design specification and drawings.

9.1.2 Many of the requirements outlined in Clause 6 in respect of buried pipelines are applicable to submarine pipelines.

9.1.3 Cathodic protection systems installed onshore to protect submarine pipelines shall comply with Clause 6 of this Standard.

9.1.4 The contractor shall be thoroughly familiar with the specifications for the works, and shall ensure that all works are completed in accordance with good industrial practice and the relevant specifications. Departures from design specifications shall be approved by design engineer and/or company and permanently recorded for future reference.

9.1.5 It is necessary that precautions be taken in combustible atmospheres to prevent sparking due to potential differences between protected and unprotected structures. Any insulated devices shall be cross-bonded before being separated, and the cathodic protection system switched off.

9.1.6 Care shall be exercised to ensure that cable and other components are protected from damage during installation. All cable connections need to provide reliable long-term low-resistance electrical contact.

9.2 For materials and equipment acceptance (or compliance) see 5.5 of general requirements.

9.3 Immersed Structures

9.3.1 Installation of impressed current systems

9.3.1.1 The installation shall be done under the supervision of a corrosion specialist to verify that the installation is made in accordance with design specification and drawings.

9.3.1.2 Impressed current anodes shall be installed in accordance with design specifications and drawings. Special care shall be taken to avoid damage to anodes and their lead wires during installation. Careful supervision of this phase is most essential to proper long-term performance of the cathodic protection system.

9.3.1.3 Impressed current anodes may be installed by one or more of the following methods:

a) Anodes may be lowered in a casing and are allowed to extend below a termination fitting at the bottom. This method provides a means of anode retrieval or replacement without diver assistance.

b) Anodes may be installed on platform members using offset steel structural supports attached to the platform members. Diver assistance is required for anode replacement.

c) Anodes may be installed on the sea bottom floor remote from the structure. The anodes may be supported by concrete foundations and buoyancy tanks to minimize the possibility of the

anodes becoming covered with mud.

9.3.1.4 Because anodes are often brittle or have thin film electrodeposited coatings, care shall be exercised to ensure that they are not damaged during handling. Certain anodes are specifically designed for suspension by their cable tails and may be lowered into position by the cable. Other anodes, generally of the direct immersion type, may need to be lowered into position by separate polypropylene ropes (see [IPS-M-TP-750](#): Part 10), as their cable tails are designed for electrical purposes only and not for mechanical suspension. The installation drawings and the recommendations of manufacturer shall be checked before commencement of anode installation.

9.3.1.5 Cable supports shall be corrosion resistant and located so that the cable insulation does not become abraded due to cable movement from wind or water forces. Cable routes shall also avoid areas of likely damage from physical operations on the structure.

9.3.1.6 Cable joints shall be completely waterproofed using an appropriate cable jointing compound (see [IPS-M-TP-750](#): Part 11). Waterproofing is particularly important on the positive side of an impressed current system to prevent localized rapid corrosion and subsequent failure of the cathodic protection system (see [IPS-D-TP-719](#)).

Note:

Proper cleaning (degreasing and abrading) of the insulation is necessary to ensure that a watertight bond is achieved between the insulation and the cable-jointing compound. Where repairs are carried out, the encapsulation shall include a minimum of 50 mm of the cable insulation each side of the repaired cable joint.

9.3.1.7 Anode to cable tail encapsulation for immersed anodes is generally fitted at the factory. Prior to installation the encapsulation shall be carefully inspected for any handling damage during transit. Anodes which project from support pipes or require centering through insulating sleeves may require diver inspection after installation.

WARNING:

Where underwater diving inspection or maintenance is likely, structures shall have warning notices displayed advising of the danger of electrical gradients near the anodes and the need to switch off the system prior to diving.

CAUTION:

Signs shall be displayed indicating the presence of any immersed cables or anode support ropes which are not physically protected.

9.3.1.8 Of special importance to be inspected during the installation is to ensure that the anode material and size are in accordance with relevant parts of [IPS-M-TP-750](#) where applicable and/or to the approved specifications.

9.3.1.9 Conductor cable connections to the rectifier, from the anode(s) and the structure, must be mechanically secure and electrically conductive. Before energizing the power source, verify that the negative (-) conductor is connected to the structure to be protected, that the positive (+) conductor is connected to the anode(s), and that the system is free of short circuits. After the direct current power source has been energized by authorization of the supervising corrosion specialist, suitable measurements shall be made to verify that these connections are correct in polarity.

9.3.1.10 Connections between the positive header cable and lead wire(s) from the anode(s) shall be mechanically secure and electrically conductive. The connections must be sealed to prevent moisture penetration and assure electrical isolation from the environment. Submerged connections require seals suitable for the water pressures and environment to which they may be subjected.

9.3.1.11 When installing a suspended anode, where separate suspension is required, care should be taken that the lead wire is not in such tension as to damage the anode lead wire or connections.

9.3.1.12 Requirements of this Standard and local authorities shall be observed during the installation of a transformer/ rectifier especially with regard to ac input, cabling and positioning. Rectifier or other power source shall be installed out of the way of operational traffic and remote from areas of extreme heat or likely contamination by mud, dust, water spray, etc. Where two or more rectifiers are installed, they shall be spaced for proper flow of cooling air.

9.3.1.13 Wiring to rectifiers shall comply with any applicable regulatory codes and with the operator's specifications. An external disconnect switch in the ac wiring to the rectifier shall be provided.

9.3.1.14 Testing of the power source shall be carried out to ensure adequate electrical connection and that no damage has occurred during installation.

The cables and connections shall be carefully inspected to detect insulation defects. Defects shall be properly repaired.

9.3.2 Installation of galvanic anode systems

9.3.2.1 Anodes shall be installed according to design specification and drawings.

9.3.2.2 Various methods for fixation of anodes to the object to be protected may be employed. The method employed shall be based on an evaluation of the design requirements to electrical connection, loading and stresses in the parts to which the anodes are attached.

9.3.2.3 The common methods of installation of galvanic anodes are as follows:

- a) By direct attachment to the structure before structure immersion.
- b) By direct attachment to the structure after structure immersion.
- c) By placing the anode on the sea-bed and connection to the structure by cable, either above or under water level.
- d) By suspension in the water from the structure via a cable or a rigid metal support, and connection of the cable to the structure above water.

In all cases, the anode shall be in reliable long-term low-resistance metallic contact with the structure. This may be achieved by the use of fusion joints or bolted connections using corrosion resistant materials followed by effective insulation (encapsulation) of the joints.

9.3.2.4 Before anode immersion, it is necessary to remove any wrapping material. The anodes shall not be painted and, where necessary, shall be protected from accidental paint application.

9.3.2.5 It shall be aimed at minimizing the drag forces caused by the sacrificial anode system.

9.3.2.6 Provisions for in-service installation of future additional current capacity shall be made. Such provisions may include spare j-tubes for additional impressed current cables. Other provisions may be "pig-tails" on pipelines and various sorts of brackets, guides, etc.

9.3.2.7 The anodes shall be attached to the structure in such a manner that they remain secure throughout the service life.

9.3.2.8 The anode core shall be welded to the structure either directly (e.g. on offshore structures) or a cadwelded cable between core and structure is used (e.g. for bracelets around pipelines).

9.3.2.9 The distance between anode and structure depends on the condition of the structure. For coated steel the minimum distance is zero, for a bare structure the minimum is 25 cm. The maximum distance is not critical provided the ohmic resistance of the interconnection is small compared with the anode resistance in the medium.

9.3.2.10 Underwater installation of anodes may be performed with mechanical fixing devices or by welding. Where the latter is done welding shall be performed in a dry environment provided by a hyperbaric chamber. Wet welding shall only be allowed on members where cracks and defects will be harmless. Mechanical fixing devices may not give reliable electrical connections for more than 5 years.

9.3.2.11 Where separate suspension is required, care shall be exercised when installing a suspended anode to ensure that the lead wire is not in sufficient tension to damage the anode lead wire, its insulation, or connections.

9.3.2.12 All galvanic anode installations shall be tested to ensure that electrical continuity exists between the anode and the structure.

9.3.3 Electrical connections

9.3.3.1 Electrical connections between anodes and steel structure shall be made by manual welding or thermit welding (see Clause 13).

9.3.3.2 For pipelines and risers, attachment welding shall be placed at least 150 mm off other welds.

9.3.3.3 Doubler plates shall be used for attachment of anode supports to pressurized parts and highly stressed structural members. Anodes shall not be located in areas with high stress concentrations, e.g. anode joints.

9.3.3.4 Doubler and/or gusset plates shall be installed on anode supports at the time of anode installation. If installed as part of the anode fabrication, these plates are subject to serious damage during anode hauling and handling.

9.3.3.5 Suspended galvanic anodes shall be installed after the platform is set on location offshore, and the anodes shall be tested for good electrical contact to the structure after installation.

9.3.3.6 Welding of doubler plates and anode supports directly on to load carrying members and pressurized parts shall be performed with a qualified welding procedure by qualified welders. These welds shall be non-destructively examined as required for welding of these components.

9.3.3.7 Attachments of electrical connections by thermit welding shall be made with a qualified procedure proved to give sufficient bonding and negligible Cu-penetration along grain boundaries. The size and shape of the mold shall suit the diameter of the pipe and the anode cable size.

9.3.3.8 Qualification of the thermit welding procedure shall be based on visual examination and mechanical testing of three test welds.

9.3.3.9 The test welds shall be sectioned and examined for bonding and possible excessive Cu-penetration using a microscope with magnification of at least 100 x. The Cu-penetration shall normally be less than 0.3 mm for procedures to be used on risers, while maximum 0.8 mm for procedures to be used on pipelines.

9.3.3.10 The hardness in the heat affected zone shall be determined on the macrosections and shall be within the normal limit specified for the pipeline system.

9.3.3.11 Welds made between anode cores and structural members for offshore facilities shall have the approval of the welding engineer. Procedure testing will often be required. Wet welding is not permitted.

9.3.3.12 Other methods used to connect anodes to structures are often used during retrofit exercises when welding is impossible. These are clamping, clamping plus hard-tipped bolting, flash stud welding in mini habitats, stud shooting, etc.

9.3.4 Corrosion control test stations, connection and bonds

9.3.4.1 Test leads to pipelines associated with offshore structures must be mechanically secure, electrically conductive, and shall be readily accessible.

9.3.4.2 Both the pipe and the test lead wires shall be clean, dry, and free of foreign material at points of connection when the connections are made. The completed connection shall be coated to prevent atmospheric corrosion.

9.3.4.3 Conductive connections to other pipelines or across insulating joints shall be installed as per paragraph 9.3.4.1. All bond connections shall be readily accessible for testing.

9.3.4.4 Steel piles shall be electrically connected by means of a continuous copper cable embedded in the concrete deck, and connected to each pile by a welding process equivalent to cadweld or thermoweld. Fender piles shall be electrically connected to main pier structure by a flexible insulated cable.

9.3.4.5 Current continuity between sections of sheet piling shall be provided by joining of adjacent sections by welding a 25 mm diameter reinforcing bar across the joints at the time of installation.

9.3.4.6 Bollards shall be installed in a manner to prevent any electrical contact between them and the steel pier piling through the reinforcing bars in the concrete deck. This will minimize the possibility of temporarily depleting the cathodic protection of the piling when a ship is moored with steel cables.

9.3.5 Installation of insulating joints/flanges and devices

9.3.5.1 All insulating flanges, or other insulating devices, shall be installed in accordance with the recommendations of the Clause 12.

9.3.5.2 The assembly of an insulating flange requires particular care to ensure that insulation is not lost or damaged due to mechanical failure of the components.

Note:

The use of resistance methods to determine the integrity of insulating flanges in the field can produce unreliable results.

9.3.5.3 Completed flanges shall be coated in accordance with design specifications.

9.3.5.4 Insulating joints shall be checked for insulation integrity, e.g. by the measurement of structure to electrolyte potential across the joint, with the reference electrode in the same location. Different potential readings usually indicate adequate insulation. If the potential readings are the same, the cathodic protection current (or changed cathodic protection current) shall be applied to one side of the joint, and the potential remeasured. If the potentials remain the same on both sides, the joint is not adequately insulated.

9.4 Submarine Pipelines

9.4.1 Installation of impressed current systems

9.4.1.1 Impressed current anodes shall be installed in accordance with design specification and drawings.

9.4.1.2 The installation shall be done under the supervision of a corrosion specialist to verify that the installation is made in accordance with design specification and drawings.

9.4.1.3 Impressed current anodes submerged in sea water may be installed by one or more of the following methods:

a) Anodes may be lowered in a casing and are allowed to extend below a termination fitting at the bottom. This method provides a mean of anode retrieval or replacement without diver assistance.

b) Anodes may be installed on the sea bottom floor remote from the structure. The anodes may be supported by concrete foundations and buoyancy tanks to minimize the possibility of the

anodes becoming covered with mud.

9.4.1.4 The anodes shall not be mounted on sand and mud unless special precautions are taken to prevent them being submerged as a result of tidal action.

9.4.1.5 When installing a suspended anode where separate suspension is required, care shall be exercised to ensure that the lead wire is not in sufficient tension to damage the anode lead wire, its insulation or connections.

9.4.1.6 Rectifiers or other power sources shall be installed so as to minimize possibility of damage, vandalism, or unauthorized entry.

9.4.1.7 Wiring to rectifiers shall comply with local and national electrical codes or requirements of utility supplying power. An external disconnect switch on ac wiring shall be provided.

9.4.1.8 The conductor (negative lead wire) shall be connected to the pipeline as described in 9.4.3. Conductor connections to the rectifier must be mechanically secure and electrically conductive. Before the power source is energized, it must be verified that the negative conductor is connected to the pipeline to be protected and the positive conductor is connected to the anodes and that the system is free of shorts. After the direct current power source has been energized by authorization of the qualified personnel responsible for corrosion control, suitable measurements shall be made to verify that the connections and polarity are correct.

9.4.1.9 Connections between header cable and conductors from anodes shall be mechanically secure and electrically conductive. All connections between anode lead wires and header cable shall be insulated and sealed to prevent moisture penetration and to ensure electrical isolation from the environment.

9.4.1.10 Where the cables cross a beach, they shall be buried in suitable backfilled trenches, with concrete slabs positioned over the cables to prevent movement or damage, or positioned and fixed in such a manner that cannot be moved or damaged by sea action.

9.4.2 Installation of galvanic anode systems

9.4.2.1 Galvanic anode systems shall be installed in accordance with design specification and drawings.

9.4.2.2 It is important that the anodes are mounted in a manner such as to avoid mechanical damage during handling and installation of pipes. Anode bracelets shall be fastened securely on the pipe. The two segments may be welded together with steel strips in order to ensure satisfactory mechanical connection and proper positioning. Each anode shall be electrically connected to the pipe by at least two attachments, preferably one from each half bracelet. The reinforcement of concrete weight coating shall not be allowed to be in electrical contact with pipe or anode.

9.4.2.3 Care shall be exercised so as not to reduce the design surface area in contact with the electrolyte. This requirement is especially applicable to bracelet anodes where there may be a possibility of anodes being covered by insulating material or anti-buoyancy material.

9.4.2.4 The contractor shall acknowledge safe receipt of anodes in writing and shall maintain records which shall correlate anode identification with relevant pipe numbers. A copy of these records shall be supplied to the Company.

9.4.2.5 The contractor shall ensure that anodes are kept undamaged during all operations. Any damaged anodes shall be segregated and reported to the Company.

9.4.2.6 Before an anode is immersed, it is important that any waterproof wrapping material be removed.

9.4.2.7 Anodes must not be painted and shall be suitably protected during any painting operations. Anodes must not be painted and shall be suitably protected during any painting operations, exception in bracelet anode on the side facing pipeline and concert Wight coating.

9.4.2.8 Electrical connections for anodes are usually incorporated within the mounting arrangement. For bracelet anodes for pipelines, cable connections to the mounting steel framework are provided

and these must terminate on the pipe.

9.4.2.9 All galvanic anode installations shall be tested to assure that electrical continuity exists between the anode and the pipeline.

9.4.2.10 Anode bracelets shall be installed as follows:

- a) Exposed steel portions of the anode shall be coated. The primer and dry film thickness of coating shall be the same as that used in pipe coating.
- b) The anodes shall be placed centrally over the pipes and clamped tightly in place. The segments shall then be welded (welder and procedure should be qualified) or bolted together as indicated on the design drawings. Bolting material shall not be high tensile and limited to a hardness of 300 vickers.
- c) Remove the coating from the areas where the bonding leads are to be welded to the pipe. The area must be cleaned to bright metal to ensure proper bonding of the weldment. Welding of cable connection shall not be carry out on bend.
- d) The bonding leads shall be welded to the pipe by the thermit welding or equivalent process (see 6.2.4). Attachment welds shall be made using consumable and procedures qualified under fully representative conditions. The qualification shall consist of one trial weld which shall be sectioned and subject to macro examination and hardness survey.

The sections shall show no cracking or copper penetration and the hardness shall not exceed 260 vickers.

- e) Repair visual damage and holidays in the primer coat on the bracelet and repair the coating over the weld and surrounding area of the pipe.
- f) Shield the bracelet with light gage sheet metal or other method approved by the Company representative while installing the concrete coating. Cut back the concrete coating mesh so that it will not be within 50 mm of the anode. An ohm meter shall be used to demonstrate to the Company representative that the reinforcement steel is not in contact with the anode.
- g) Gaps between the anode bracelets and between the anodes and the concrete coating shall be filled with non-conductive mastic or similar compound infill to produce a smooth surface across the bracelet with only the exterior curved surface of the anode exposed.

9.4.3 Corrosion control test stations, connections and bonds

9.4.3.1 Electrical continuity between the test point and the pipeline shall be proven by means of a continuity tester, indicating zero resistance.

9.4.3.2 The test point shall, where possible, be constructed prior to the application of the pipeline weight coating system and care shall be taken to ensure that all bare metal is insulated (except for the point of contact used for the test point).

9.4.3.3 Care shall be taken to ensure that the reinforcement in the anti-buoyancy weight coating material does not come into contact with the test point and that a minimum of 30 mm clearance between the reinforcement and the test point shall be maintained.

9.4.3.4 Test points shall be installed as required, but will be located midway between sacrificial anodes.

9.4.3.5 Connections of test lead wires to pipelines above water must be installed so as to be mechanically secure and electrically conductive. Pipe and test lead wires shall be clean, dry, free of foreign material and properly coated.

9.4.3.6 Conductive connections to other pipelines or across electrical isolating devices shall be mechanically secure, electrically conductive and suitably coated. Bond connections shall be accessible for testing.

9.4.4 Reinforcement

9.4.4.1 Pipeline weight coating reinforcement material shall be carefully installed in accordance with standard specification of [IPS-C-TP-274](#).

9.4.4.2 Each pipeline section shall be inspected and tested using a 1000 Volt insulation test set to ensure that the reinforcement is not in contact with the pipe wall. A minimum reading of 1 M ohm will be regarded as satisfactory.

9.4.4.3 After each joint has been completed the pipeline section reinforcement shall be insulation tested from the remote end, this will be applicable for both lay barged and bottom pull pipelines.

9.4.5 Pipeline crossings

9.4.5.1 Where two or more pipeline crosses, test points shall be fitted to the pipeline and positioned to coincide with the crossing.

9.4.5.2 Where test points for bonding purposes have not been installed, a clamp arrangement with set screw shall be utilized. Care shall be taken not to damage the coating and the pipeline. The set screw shall be tightened only sufficiently to make a good electrical contact but not to damage the pipe wall.

10. ELECTRICAL MEASUREMENTS AND TESTS

10.1 General

10.1.1 This Clause 10 indicates the apparatus needed and the techniques for measuring voltage, current and resistance, and testing for continuity of structures to ensure the successful commissioning of a cathodic protection installation. Some survey techniques are described.

10.1.2 Electrical measurements and inspections are necessary to ensure that initial protection of the structure has been established in accordance with applicable criteria, and that each part of the cathodic protection system is operating satisfactorily.

It is important for subsequent system checks to be carried out to ensure that the structure remains protected and, if changes are noted, that action is taken to return the system to a protected condition.

Whenever the surface of a structure is exposed, the condition of the coating shall be noted, and the coating repaired appropriately.

10.1.3 It shall be the responsibility of the contractor to perform all precommissioning and commissioning checks on the cathodic protection systems as outlined in this Construction standard.

10.1.4 It shall be the responsibility of the contractor to supply all test equipment to perform the tests outlined in this Construction standard.

10.1.5 All tests performed by the contractor will be witnessed by and shall be completed to the satisfaction of the Company.

10.1.6 The contractor shall carry out and document all tests under the supervision of the Company representative.

10.1.7 The inspection and testing shall not cause danger to persons or livestock and shall not cause damage to property and equipment.

10.1.8 Under no circumstances shall any cathodic protection system be energized before inspection and testing is completed.

10.1.9 The stages at which these tests are carried out on particular installations are indicated in the appropriate clauses.

10.1.10 Tests for corrosion interaction interferences are dealt with in Appendix A.

10.2 Potential Measurements

10.2.1 Instruments

10.2.1.1 The meters and equipment used for potential survey and testing are described in 7.1.3 and Appendix A of [IPS-I-TP-820](#).

10.2.1.2 All instruments used for determining electrical values shall be of an appropriate type and be of the required accuracy. They shall be maintained in good working condition at all times.

10.2.1.3 Where fluctuations in the electrical measurements are noted, it may be necessary to substitute recording instruments for meters during surveys.

10.2.1.4 Electrodes other than copper/copper sulfate and silver/silver chloride may be used, provided that their relationship with these electrodes is either known or established prior to each measurement (see [IPS-I-TP-820](#)).

10.2.2 Potential survey of buried structures

For methods of survey reference is made to 7.2 of [IPS-I-TP-820](#).

10.2.3 Potential survey of offshore structures

For methods of survey reference is made to 7.4 of [IPS-I-TP-820](#).

10.2.4 Potential survey of internal protection of plant

10.2.4.1 General

With fully enclosed plant, it is normally necessary to install permanent measuring points or reference electrodes. Where the positions at which measurement should be made can be predicted, these facilities are preferably installed before commissioning.

Alternatively, potential surveys can be carried out (see 10.7.4) initially with temporary equipment to determine the positions where the potentials are most positive and whether the most negative potentials are acceptable.

10.2.4.2 Permanently-installed reference electrodes

The most convenient method of mounting reference electrodes inside plant is by means of a 'screw-in' assembly such that the electrode can easily be withdrawn for inspection and replacement of either the entire unit or the electrode material.

The electrodes can be wired to central monitoring and control equipment. A disadvantage lies in the difficulty of checking the accuracy of the electrodes, once installed.

For detailed potential surveys, or if it is impossible to use 'screw-in' mountings, reference electrodes can be attached by suitable non-metallic fixings to the protected surface and the insulated connecting leads brought out through the plant wall through a suitable gland.

Generally, it is advisable to install at least one reference electrode for each cathodically-protected compartment. The reference electrode should be installed at the position where corrosion is most likely, e.g. at junctions of ferrous and non-ferrous materials and/or remote from anodes.

10.3 Direct Current Measurement

The methods of testing for current measurements are described in B.4 of [IPS-I-TP-820](#).

10.4 Resistance Measurement

10.4.1 Soil resistivity measurements

(See Appendix B).

10.4.2 Earth electrode resistance measurements

The necessary method of testing are described in Appendix C.

10.4.3 Determination of bond resistance

Where it is necessary to determine the value of the resistance which should be connected in series with a bond, to adjust the structure electrolyte potential of a structure to a desired value. It can be done either by inserting a series of fixed calibrated resistors until a suitable value is found, or adjustment can be made by using a variable resistor, the resistance of which is subsequently measured. Alternatively, if the galvanometer shown in Fig. 1 is calibrated to indicate voltage, the desired potential conditions on the structure can be obtained by adjustment of the resistor. The necessary resistance value is determined as the ratio of the voltage to the current. This arrangement has the advantage of obviating the need for low resistance leads. Special milliohm meters are also available for measuring the very low resistance of bonds.

10.4.4 Continuity of structure

The method of testing are described in B.12 of [IPS-I-TP-820](#).

10.5 Field Testing of Electrical Isolating Equipment

For methods of testing refer to B.1 of [IPS-I-TP-820](#).

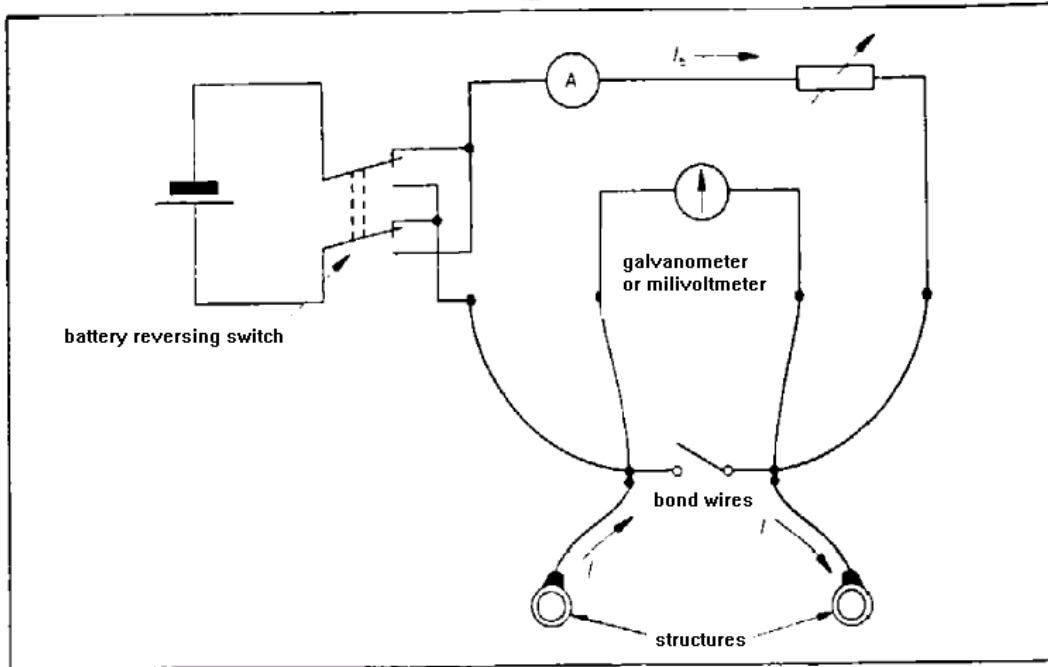

ZERO RESISTANCE AMMETER CIRCUIT USED TO MEASURE CURRENT FLOWING IN A BOND (BOND DISCONNECTED)

Fig. 1

Note:

With current I_b adjusted to give no deflection on the galvanometer I_b is equal to the bond current.

10.6 Tests Prior to Installation of Cathodic Protection on Buried or Immersed Structures

10.6.1 Soil resistivity

(See Appendix B).

10.6.2 Soil/water evaluation

10.6.2.1 Soil/water sampling

- Soil samples may be obtained from along the pipeline route with a minimum of one sample from each type of soil noted to exist. Samples are to be ideally between 250 g and 2,000 g and placed in sealed, sterile, air tight containers and should fill the containers completely.
- Where bacteriological analysis is to be undertaken, the soil sample is to be as little disturbed as possible and completely fill the containers.
- Soil samples are obtained from depth either by excavation or by auguring techniques.
- Water samples may be obtained from river, estuaries and water logged locations. Samples need to be ideally between 1 and 2 liters, placed in sealed, sterile, air tight containers and fill the containers completely.
- In the case of immersed structures, any analysis of water samples shall include measurement of the oxygen content and conductivity. It should be noted that, particularly in the case of estuarine waters, considerable variation can occur according to the state of the tide and also according to the season. Moreover, stratification is often present and the use of a suitable sampling technique is recommended.
- The analysis is to be completed with the minimum of delay from time of sampling.

10.6.2.2 pH measurements

- After resistivity measurements, pH is perhaps the most widely used test for corrosivity. Where corrosion could be caused or enhanced by chemical attack, the pH measurement may be used to assess this risk.
- The methods available for pH measurement include:
 - glass electrode and millivoltmeter;
 - colorimetric;
 - indicator papers.
- Glass electrodes may be used with either potentiometric or high impedance millivoltmeters. Both types are available as portable, battery-powered units for field use. Apparatus, reagents and procedures are listed in both ASTM G51 and BS 1377.
- Colorimetric techniques are also described in BS 1377 and may be used as rapid field techniques. However, results can be erratic and excessive turbidity in the soil may mask end point.
- Indicator papers are a practical site method and are sufficiently accurate for most survey purposes. Dry soils may be wetted with de-ionized water for this technique.

10.6.2.3 Soluble salts

Chemical analysis for salts is usually restricted to chlorides, sulphates, carbonates and sulphides. The latter two being analyzed qualitatively and chlorides and sulphates analyzed quantitatively. Quantitative analysis of chlorides and sulphates is undertaken by gravimetric, volumetric or colorimetric (semi-quantitative) analysis. The gravimetric and volumetric analysis of sulphates is detailed in BS 1881. For corrosion purposes, only the water-soluble sulphates are of concern, rather than total sulphates.

- A quick assessment of resistivity of water may be made from the value of total dissolved solids by the following formula:

$$\frac{6,250}{\text{Total Dissolved Solids}} = \text{Resistivity in ohm} \cdot \text{m}$$

10.6.2.4 Bacterial analysis

There are a number of micro organisms which thrive in or create conditions conducive to corrosion. These principle organisms are supho bacteria, ferri bacteria and sulphate reducing bacteria. In soils the most common form of bacterial corrosion is caused by sulphate reducing bacteria. These bacteria are most active in anaerobic soils when the hydrogen ion concentration is near neutral, pH 7.0, but are known to grow in the range pH 5.5 to 8.5. In their action they convert sulphates in the soil to sulphides.

Various approaches exist to detect soils in which sulphate reducing bacteria are likely to thrive. They are:

- Redox potential

Redox potentials are measured in the field by measuring the potential of a platinum electrode using a calomel reference (see Appendix E). The reading is pH corrected.

The general accepted criteria for microbial corrosiveness as quoted in BS 7361 are:

Redox potential	100 mV severe
corrected to pH7	100-200 mV moderate
(mV Standard	200-400 mV slight
Hydrogen Electrode)	400 mV non-corrosive

This technique is probably the most widely used for assessing microbial activity. Reproducibility of results is, however, poor and the equipment can only be used with confidence in relatively soft soils.

- Detection and Enumeration

Detection of sulphate reducing bacteria is undertaken by using one of a number of culture media which includes Bars, Postgate and API media. Generally, the culture consists of a

nutrient, an indicator and a redox poisoning agent with the pH adjusted to near neutral.

Enumeration is carried out by using a series dilution. After solidification of the culture medium and 2 day incubation, the colonies of bacteria can be counted.

- Chemical Tests

These basically cover sulphate content, organic materials content, soluble iron and hydrogen uptake of the soil.

10.6.2.5 Moisture content

Moisture content of soils may be determined by one of the methods described in BS 1377.

10.6.3 Structure/electrolyte "natural" potential survey

The structure/electrolyte potential survey shall be carried out to determine the structure/electrolyte potential variation along, or over the surface of the structure (see 10.2).

Such a set of potential measurements may indicate those points on the structure where the worst corrosion is likely to be taking place.

With no applied cathodic protection, and in the absence of stray currents, the most negative structure electrolyte potentials indicate the corroding areas. On the other hand, if corrosion is due predominantly to stray current in the soil, the more intense corrosion will be associated with the more positive structure/electrolyte potentials.

10.6.4 Stray electric currents

Where the presence of stray electric currents is suspected, e.g. in proximity to d.c. electric traction systems or where varying structure/electrolyte potentials indicate the possibility of such currents, it is necessary to determine more accurately the extent of stray current effect on the structure. This can be done by plotting the potential field in the area, using a stationary reference electrode, or a structure, as a reference point.

The necessary methods of testing are described in Clauses 11 and B.11 of [IPS-I-TP-820](#).

10.6.5 Tests for electrical continuity

Tests shall be carried out whenever the continuity of the structure is in doubt, to locate any discontinuities in accordance with Clause 8.4 and B.12 of [IPS-I-TP-820](#).

10.7 Tests During the Commissioning Period

10.7.1 General

The structure/electrolyte potentials at various points on a structure will continue to change for some time after protection has been applied. Tests shall, therefore, be made at intervals and currents adjusted as necessary until conditions become stable with potentials at all points not less negative than the values given in protection criteria (refer to Clause 6 of [IPS-I-TP-820](#)).

A comprehensive survey shall then be made and the results analyzed to provide a list of conveniently carried out tests by which the continued satisfactory operation of the protection system can be confirmed.

Immediate action shall be taken if abnormally positive changes in potential occur, particularly at the point(s) of application of current indicating that one or more transformer-rectifiers have been reversed.

More frequent inspections (for example at monthly intervals) are recommended where:

- a) The non-operation of one transformer-rectifier would result in a total or partial loss of

protection;

b) The non-operation of the transformer-rectifiers is likely, due to factors outside the operators control, e.g. known unreliable power supplies, joint operation with a third party, susceptibility to electrical storms; or

c) Protection is provided by a single bond from another protected structure.

It is important that commissioning and routine test readings shall be permanently recorded. In many instances, comparison with these provides the only information that is available as to the condition and performance of the system. To this end, a routine shall be established for the periodic review of the measurements to ensure that the conditions are satisfactory. Consideration shall be given to the computerization and graphical presentation of records, with the inclusion of exception reporting for test measurements that fall outside set limits.

10.7.2 Buried structures

Structure/electrolyte potentials shall be measured at a series of points including, particularly, points remote from the groundbed or anode positions.

Outputs shall be adjusted to the minimum that gives the desired level of protection.

The period required for the potentials to become stable may vary from a few days for a well-coated structure, to a few months for a bare or poorly coated structure.

Where possible, currents from individual sacrificial anodes or transformer-rectifier units shall be measured. In the case of a complicated pipe system, it is also useful to measure the current flowing from individual branches or sections.

Once the operating conditions have been established, organizations that might be installing underground equipment in the area in the future shall be given sufficient information for them to be aware of possible interaction problems. This will include, for example, groundbed positions and expected currents, and, if not already provided, and indication of the routes of the protected structure and of any structures that have been bonded to it to reduce interaction.

10.7.3 Fixed immersed structures

Structure/electrolyte potentials shall be measured, at the points provided, soon after the protection is switched on. Individual (or group) anode currents shall be measured and adjusted to the minimum that gives protection.

The structure potential shall be measured by connecting a high input-impedance voltmeter (at least 1 M.) to the structure, usually at a test point, and placing a reference electrode, connected to the positive terminal of the voltmeter, as near as practicable to the immersed surface of the structure (see Fig. 3).

Because accurate measurement of the structure potential requires the reference to be located at the surface of the structure, the reference electrode may be located by a diver, a remotely operated vehicle or be permanently installed at various areas of the structure (such as areas of complex geometry or where shielding can occur). Such readings can then be related to readings taken with a reference electrode placed adjacent to the side of the structure.

Care shall be taken to ensure that the structure component to which the measuring voltmeter is connected is not carrying a substantial cathodic protection current. With impressed current systems, in particular, parts of the structure may be carrying a large current and hence may cause a significant voltage drop error in the measurement.

10.7.4 Internal protection of plant

Structure/electrolyte potentials shall be measured at the test points before and soon after the installation is switched on (see Fig. 4). The currents at individual anodes (or groups of anodes) shall be monitored and adjusted as necessary after a further period, e.g. one week, then, if no serious departure is observed, again after one month. At each adjustment, the individual and total anode

currents shall be noted for reference.

Each sensing electrode used for automatic control shall be checked against a suitable reference electrode installed close to it. Unless there is experience with similar plant, reference electrodes shall also be installed at a sufficient number of positions in the protected equipment to enable a representative potential distribution curve to be plotted. This will show whether the position of the sensing electrode was chosen judiciously and whether the correct control setting has been selected. If more than one sensing electrode provides the feedback signal to the controller, the readings on each shall be compared for incompatibilities before and after switching on the protection. Readings may show differences due to the presence of electropositive materials, and the gradients around anodes. Ideally, all the sensing signals shall be within 50 mV when the protection is switched on. Slightly wider tolerances (e.g. 100 mV) may still form an acceptable basis for control.

10.7.5 Internal surfaces

The structure potential shall be measured by connecting the positive terminal of a high-impedance voltmeter (at least 1 megohm) to the structure, usually at a test point. The negative terminal shall be connected to a reference cell which is positioned as near as practicable to the immersed surface of the structure. (see Fig. 5).

Because accurate measurement of the structure potential requires the reference to be located at the surface of the structure, the reference electrode may be carried by a remotely operated vehicle or be permanently installed at various areas of the structure (such as areas of complex geometry or where shielding can occur). Accurate readings of the structure potential can then be related to readings taken with a reference electrode placed adjacent to the side of the structure.

Care shall be taken to ensure that the structure component to which the measuring voltmeter is connected is not carrying a substantial cathodic protection current. With impressed current systems, in particular, parts of the structure may be carrying a large current and hence may cause a significant voltage drop error in the measurement.

10.8 Specialized Surveys

There are a number of specialized survey techniques being utilized to provide additional detailed data concerning corrosion prevention systems.

These techniques would normally be carried out by specially trained personnel using purpose-built equipment and instrumentation, often only available from specialist contractors. These surveys are generally time-consuming but the information gained may not be available from other methods.

The surveys covered by this Standard are:

- 1) Surveys for detecting external pipeline coating defects, i.e.:
 - Pearson survey.*
 - Electromagnetic current attenuation survey.*
 - Close interval pipe to soil potential survey.*
 - Direct Current Voltage Gradient (DCVG).
- 2) Surveys to determine the effectiveness of cathodic protection systems, i.e.:
 - Close interval pipe to soil potential survey.*
 - Current drainage survey. (see Appendix D).

* For the methods of above surveys see Appendix B of [IPS-I-TP-820](#).

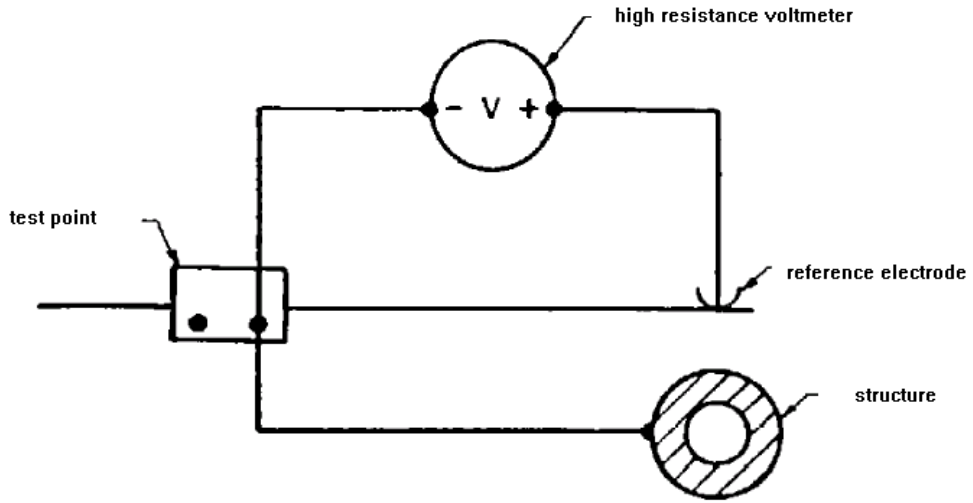

STRUCTURE POTENTIAL MEASUREMENT

Fig. 2

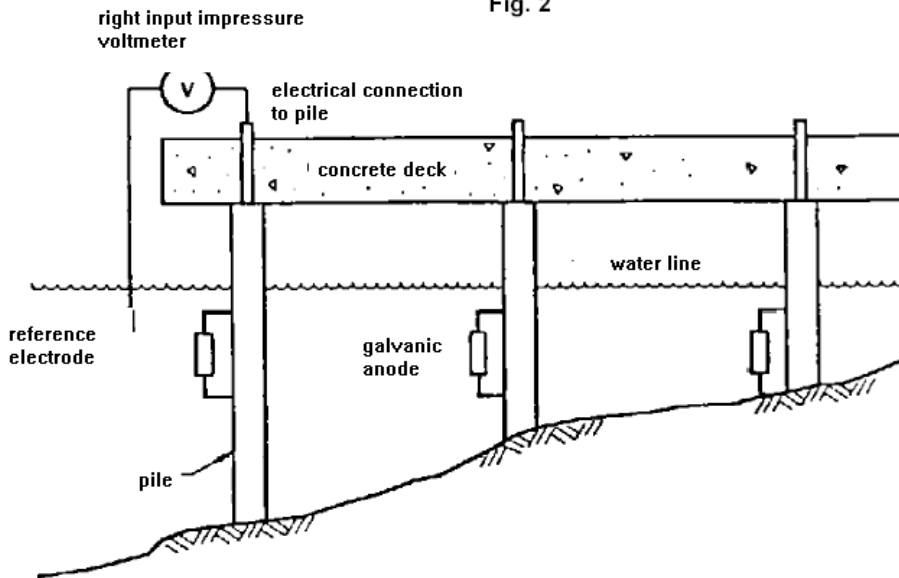

MEASUREMENT OF STRUCTURE POTENTIAL ON FIXED IMMersed STRUCTURES

Fig. 3

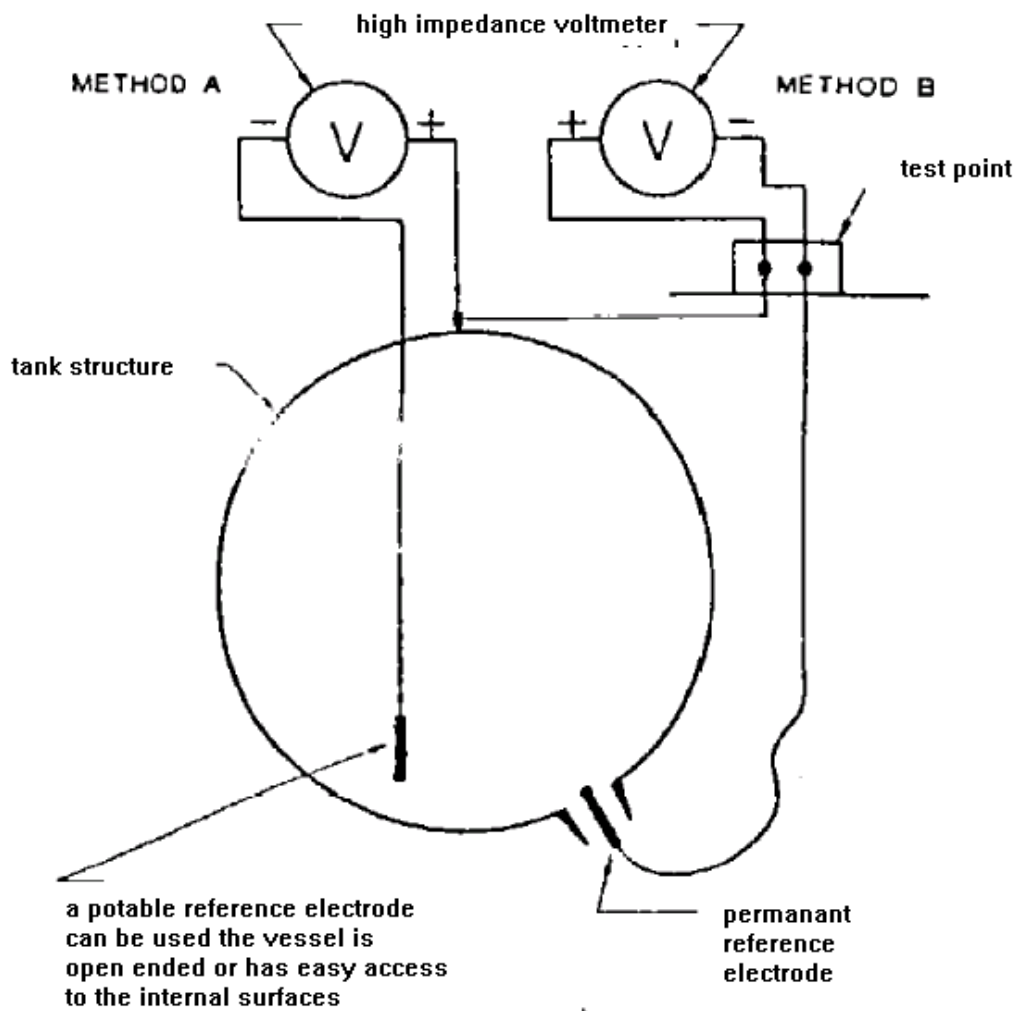

ALTERNATIVE METHODS FOR MEASURING STRUCTURE POTENTIALS

Fig. 4

Note:

- 1) Method A employs a portable reference electrode.
- 2) Method B employs a permanent reference electrode.

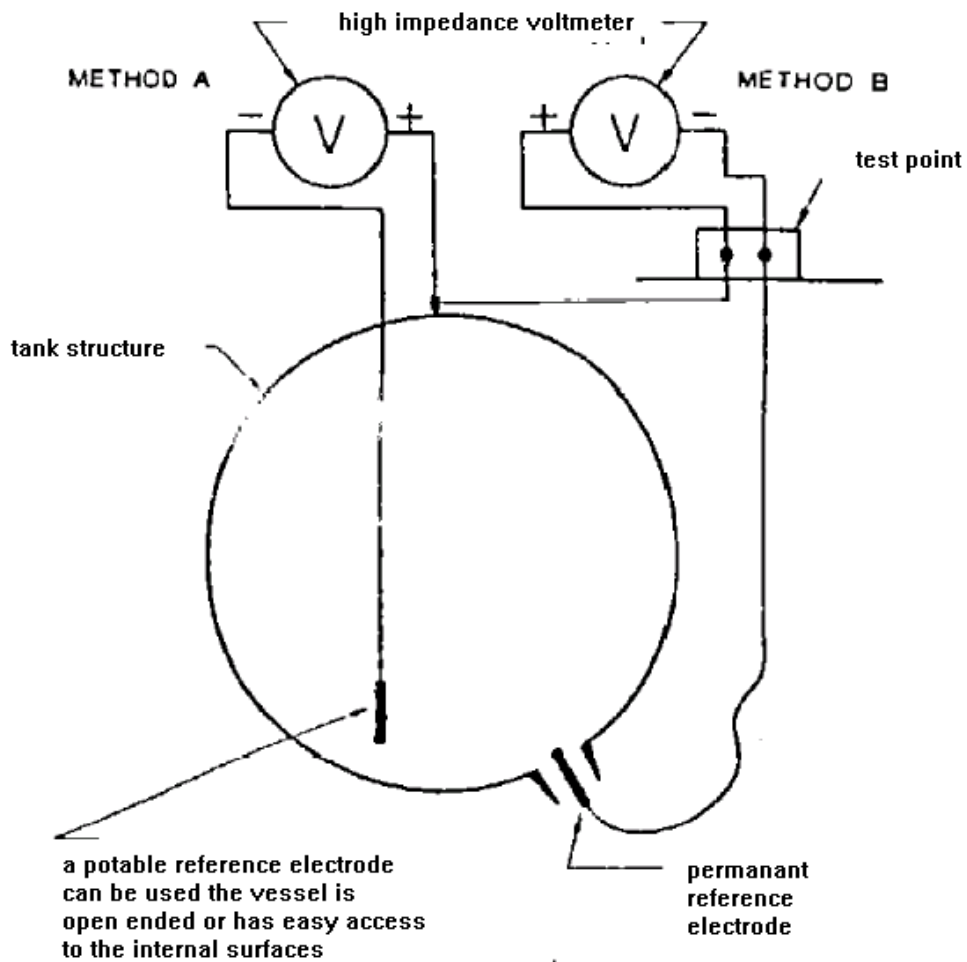

Notes:

- 1) Method A employs a portable reference electrode.
 - 2) Method B employs a permanent reference electrode.
 - 3) The polarity shown is for digital, off-set zero and center-zero voltmeters.
- When using direct reading voltmeters the test leads need to be reversed to obtain negative potential readings.

ALTERNATIVE METHODS FOR MEASURING INTERNAL STRUCTURE POTENTIALS

Fig. 5

PIPE-TO-SOIL POTENTIAL DISTRIBUTION ON WELL-COATED AND BADLY COATED PIPELINES

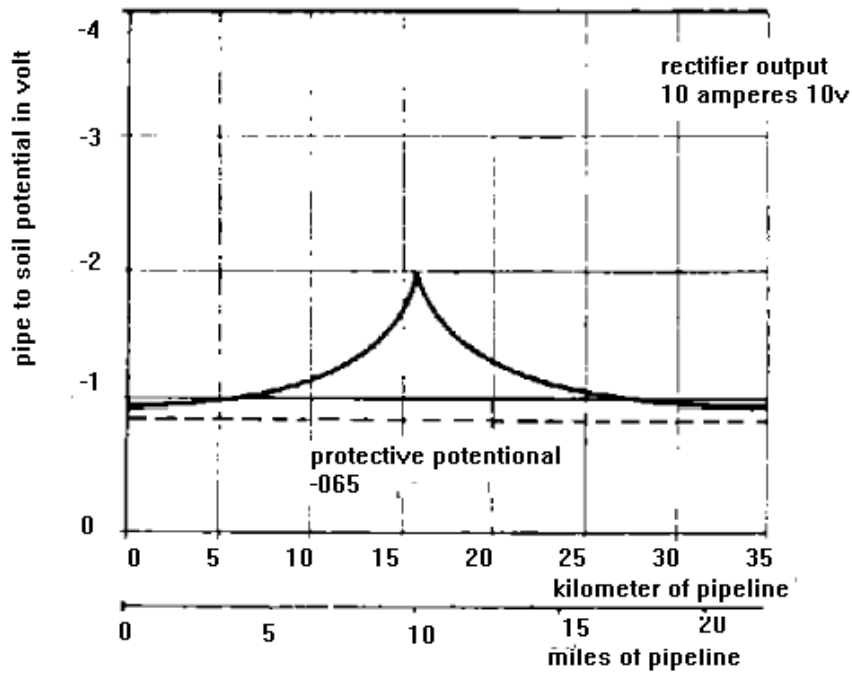

well coated pipeline

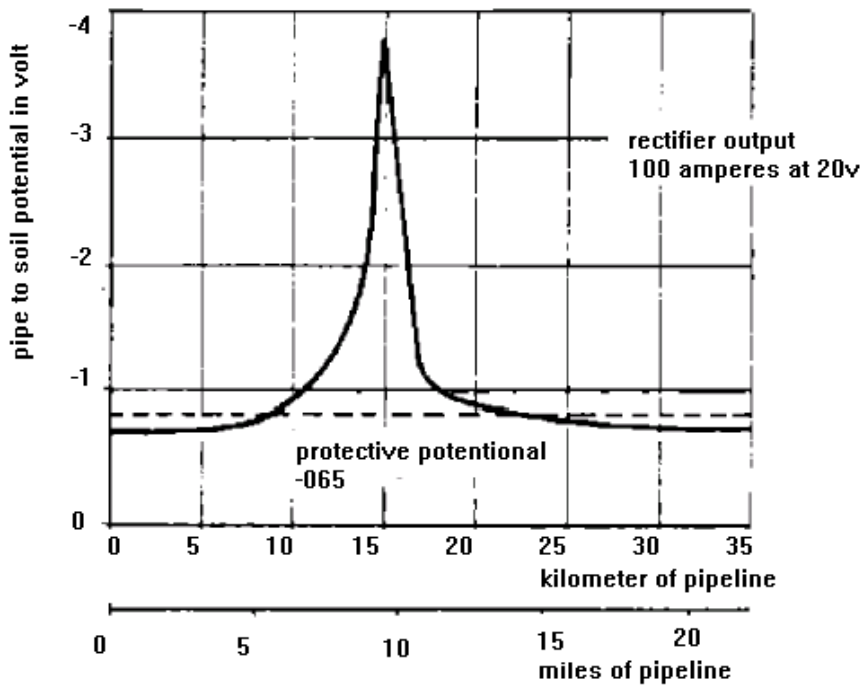

badly coated pipeline

11. COMMISSIONING OF CATHODIC PROTECTION SYSTEMS

11.1 Introduction

11.1.1 This Clause 11 indicates the stages at which tests shall be made for commissioning of cathodic protection systems for buried and immersed structures, tanks, and internally-protected plant.

11.1.2 The relevant test instruments and the techniques for their use are described in [IPS-I-TP-820](#).

11.1.3 The effectiveness of a cathodic protection installation depends on applying and maintaining the correct potential difference between the structure and the adjacent environment at all parts of the structure. This is the objective of the procedures described in this Section. The criteria for cathodic protection shall be in accordance with Clause 7 of [IPS-E-TP-820](#).

11.1.4 The contractor shall ensure that the check-out and commissioning procedures are sufficient to demonstrate that the cathodic protection system installation satisfies the criteria established by the Company project tender documents and the associated company specifications and drawings.

11.2 Precommissioning Inspection and Check

11.2.1 Every cathodic protection installation shall be inspected and tested by contractor before commissioning test, this is to ensure as far as practicable that all the requirements of the contract has been carried out and installation is ready for precommissioning. The contract requires that the test carried out shall not in any way be a danger to persons, property or equipment.

11.2.2 The Engineer is entitled to inspect, examine and test the workmanship during the course of installation; any such inspection shall not release the contractor from his obligation under the contract. Any work in the opinion of the Engineer which is not up to standard shall be rectified at the contractor own expense.

11.2.3 A program shall be provided for precommissioning test with the approval of Engineer.

11.2.4 All provision such as testing equipment, special tools and coordination for availability of power and all pertinent work permit shall be envisaged.

11.2.5 The written programs for check-out and commissioning, including detailed check sheets, shall be submitted 45 days prior to the scheduled date for beginning check-out and commissioning activity.

11.2.6 The Company-approved design drawings and specifications shall form the basis for the construction of the cathodic protection system.

11.2.7 In addition to these drawings, the Company will furnish the Vendor drawings for all company-supplied equipment. The contractor shall furnish the vendor drawings for all equipment supplied by the Contractor.

11.2.8 The Contractor shall make as-built corrections to both the Company supplied and contractor-supplied drawings, including all changes required during check-out and commissioning.

11.2.9 Detailed check sheets shall be developed as part of the check-out and commissioning procedure prepared by the Contractor. The check sheets shall have provisions for certifying that the various individual equipment items are properly installed in compliance with the specified performance and safety requirements and are suitable for operation.

11.2.10 The detailed check sheets shall be standardized for each type of CP systems and shall contain as a minimum:

- Checks and tests conducted.
- Record of test results.
- Acceptance signatures.

- Equipment tag number.

11.2.11 The contractor, in collaboration with the engineer, shall carry out all precommissioning checks of the completed system. Duties in this connection, consist of, but are not limited to the following:

- Transformer/rectifiers

The contractor shall check the transformer/rectifier units for correct polarity, supply voltage, fuse rating, and full load test. The contractor shall endeavor to keep the time for full load test as minimum as possible. In addition, the testing of the transformer/rectifiers shall be carried out to ensure adequate electrical connection and that no damage has occurred during installation.

- Groundbed

Groundbed resistance test shall be made as soon as the groundbed is installed and backfilled, under the supervision of the Engineer.

- Cable test

The Contractor shall ensure adequate care is taken during installation and backfill to prevent damage to the wiring insulation and shall test the wiring, after backfilling, for continuity, with a low voltage test. The method and results shall be approved by the Engineer.

- Insulating joints

After the hydrostatic test and before gas commissioning, the contractor shall make an electrical test to verify the insulation of the joint. The minimum value shall not be less than one thousand (1000) ohms.

After commissioning, the effectiveness of the insulation shall be tested by Cathodic Protection Impressed Current. In this test, the current will be drained from one side of the insulating joint to the extent that a negative swing of potential of 400 mV is maintained. In this case, insulating joint is accepted if the potential on the unprotected side of the joint remains natural or becomes more positive. Insulating joints found defective after installation shall be replaced by the contractor at his expense.

- Cased crossing

Test on cased crossings shall be made in accordance with B.1 of [IPS-I-TP-820](#).

During commissioning of the cathodic protection system, tests on the casing insulation will be conducted again by draining cathodic protection current in such a way that a minimum negative swing of 400 mV is achieved on the carrier pipe. In this case, the insulation shall be effective if the potential of the casing shifts towards positive.

Results of the above tests shall be approved by the Engineer. All the foregoing tests and remedies of work shall be at the contractor's expense.

- Test stations (test points)

All installations shall be subject to test during construction and on completion of the work. Should any test point prove faulty or damaged in construction and/or installation, the contractor shall rectify the defect(s) as soon as discovered and/or instructed by the engineer.

- Earthing system

Check completed earthing system for continuity of main earthing system loop and continuity of all

taps to equipment.

Check earthing system using a megger earthing resistance tester or the type which balances out the reference grounds.

Earthing resistance values in all of the above tests shall be 5 ohms or less. If greater than 5 ohms, supplemental ground rods shall be installed until an acceptable value is obtained.

11.3 Hook-up and Commissioning

11.3.1 General

11.3.1.1 All work shall be executed in strict accordance with the Company-approved drawings and specifications. The written approval of the Company representative is required for any deviations by the contractor from these drawings and specifications.

11.3.1.2 The contractor shall bring to the attention of the Company representative any areas of the drawings and/or specifications which conflict or do not meet safe and acceptable practices.

11.3.1.3 The Contractor shall be responsible for the protection and security of all materials and equipment during all stages of commissioning.

11.3.1.4 The Contractor shall not perform any tests that would either void the Vendor warranty or damage the materials and equipment.

11.3.1.5 The Contractor shall tie-in the ac power source to the rectifier(s) with all work carried out by qualified electricians.

11.3.1.6 The Contractor shall be responsible for all aspects of the system(s) start-up.

11.3.1.7 An "Adjustive Survey" shall be provided to the Company within thirty (30) days of system start-up.

11.3.1.8 The Contractor shall submit with the "Adjustive Survey" the following additional documentation on cathodic protection system(s):

- a) Copies of accurately dimensioned "As-Built" drawings of all installations.
- b) Copies of operating and maintenance manuals for all equipment provided and installed by the Contractor.

The above information, when available shall be incorporated in the plant data books.

11.3.1.9 Written programs for commissioning of CP system shall be developed by the contractor. These programs shall include detailed check sheets and shall be submitted for acceptance to the Company at least 45 days prior to the scheduled commencement of the check-out and commissioning activity.

11.3.1.10 The commissioning program shall detail the final tests to be conducted on all equipment after the check-out program is complete. The commissioning program shall demonstrate the proper operation of the complete CP system.

11.3.1.11 All check-out and commissioning shall be witnessed by the Company representative.

11.3.1.12 Check-out tests may be conducted concurrently with commissioning tests.

11.3.1.13 The Contractor shall submit a full report to the Company at completion of commissioning (see 11.5).

11.3.2 Impressed current systems

11.3.2.1 After completion of the installation, check-out, inspection and testing of the cathodic protection equipment, it is necessary to carry out the following procedures.

11.3.2.2 Prior to energization of the cathodic protection systems, the contractor shall carry out a natural potential survey all along the length of structure under protection at all test points and current drainage points.

11.3.2.3 The transformer/rectifiers then shall be energized for a minimum period of 72 hours before any measurements are taken.

11.3.2.4 The contractor shall adjust the current by steps to limit the drain point potential according to the criteria for the steel under protection (refer to Clause 6 of [IPS-I-TP-820](#)).

11.3.2.5 During the polarization period with impressed-current systems, regular checks of structure potential and transformer-rectifier output shall be made in order to avoid gross over-protection.

11.3.2.6 The frequency of subsequent T/R readings depends on the reliability of the power supply. Readings taken once per fortnight are often chosen to start with.

11.3.2.7 During the polarization period the current output of the transformer-rectifiers shall be progressively reduced to maintain the steel-to-soil potential at its desired level.

11.3.2.8 Once all the transformer/rectifiers have been energized, applied potentials shall then be taken at the same location as for the natural potentials.

11.3.2.9 Should the interphase potential between two groundbed installations be higher than the minimum criteria laid down, this usually being 0.95 Volts, the drain point potential should then be adjusted to a lower potential to prevent wasteful losses of power at the installations.

11.3.2.10 Particularly in high-resistivity soils voltage drop through the soil as a result of applied current for cathodic protection can be considerable. As a result the potentials measured on the surface over the pipe whilst the current is 'on' will not reflect the potential at the pipe surface.

11.3.2.11 In order to measure a more true potential the current shall be switched off momentarily, the potential (the 'off' potential) shall be measured immediately after interruption (within seconds). This potential is not affected by any voltage drop in the soil. Transformer-rectifiers should be equipped with automatic and synchronizable interrupters for this purpose.

11.3.2.12 It is necessary to repeat this test after polarization has taken place, approximately 14 days. This may require further adjustments of the current output of the transformer/rectifier to keep the applied potentials between the minimums and maximums laid down.

Notes:

1) Besides, the detailed information related to the design, construction and commissioning of the installation, records shall be kept of current outputs and protective potentials. The data shall be analyzed after each survey and corrective action taken soonest but within one month. Whenever a cathodic protection system is installed the necessary instruments shall be purchased to enable the engineer-in-charge to make the required measurements.

2) After a protective current has been applied by an impressed-current cathodic protection system polarization of the protected structure occurs, causing a gradual fall in current requirements. The rate at which polarization occurs depends on the nature of the medium surrounding the structure and on the current density; the time elapsing before the current requirement falls to a steady value while maintaining the structure at the desired potential may vary from a few days to many months.

3) The reference electrode shall be located in contact with the surface of the earth directly over or not more than five or six pipe diameters away from the structure along the surface of the earth at selected locations as indicated on the drawings. When measuring the potential of a tank, the reference shall be placed a half tank diameter away from the structure.

4) Variable resistors shall be installed in the negative drain circuit, if required, to balance the current to each of the adjacent pipelines. Each negative circuit shall be provided with a suitably sized shunt and diode at the DC source. The installation of the diode is required to prevent mutual influence of pipelines during "on-off" surveys.

11.3.3 Sacrificial anodes

11.3.3.1 During the polarization period, regular checking of potentials shall be carried out to obtain early warning in case the system is inadequate.

11.3.3.2 The potential of the protected structure can never become more negative than the anode potential itself. The latter is usually well within the range of acceptability.

11.3.3.3 Current output from the anodes is self-regulating since with further depressed potentials of the structure, the driving force between anode and cathode becomes smaller. This automatically results in a lower current drain. Calculation will show that zinc and aluminum anodes can provide approximately twice the design current at the very start of the polarization period, with the advancement of the polarization the current gradually reaches the equilibrium state (which could be lower than the design current drain).

11.3.3.4 The sacrificial anode system usually comprises 2 cables connected to the structure, one for measuring the applied potential and the other to be connected through a terminal panel and a removable link to the sacrificial anode. The removable link is maintained for the measurement of current between the anode and the structure. A sensitive milliammeter with a very low internal resistance is connected between the terminals after the link has been removed and a measurement of the current output is taken. This measurement shall be taken as quickly as possible to prevent depolarization between the anode and the structure since increased current will be required should the structure depolarize.

11.3.3.5 With anodes used suspended under water and accessible, an indication of the probable remaining life can be obtained by periodic lifting and weighing. A comparison of the rate of wastage will also show the extent to which individual anodes are contributing to the protective system.

11.3.3.6 When sacrificial anodes are used to protect condenser end-plates, box coolers, and similar equipment, visual inspection together with potential measurements provide a method of checking.

11.3.4 Interference

11.3.4.1 The application of cathodic protection with impressed current to a buried or immersed structure (referred to as the primary structure) causes direct current to flow in the earth or water in its vicinity. Part of the protection current traverses nearby buried or immersed pipes, cables, jetties or similar structures alongside (termed secondary structures), which may be unprotected and the corrosion rate on these structures may, therefore, increase at points where the current leaves them to return to the primary structure.

11.3.4.2 Interference with other buried or immersed installations shall be measured by the contractor in the presence of the Engineer and, the owners of the foreign structures, after switching-on the Impressed Current Cathodic Protection System (see Appendix A).

11.3.4.3 The Contractor shall conduct the tests according to the methods described in Appendix A with the understanding that the criterion is the swing of the potential of the foreign structure from the natural value. The test procedure is detailed hereunder:

- a) The foreign structure-to-electrolyte potential shall be taken while the transformer-rectifier is turned-off.
- b) Structure-to-electrolyte potential shall be taken while the transformer-rectifier is "on position".
- c) Several readings shall be made by the contractor for comparison.

11.3.4.4 The maximum positive swing of potential at any part of foreign structure resulting from interference shall not exceed 20 mV and, in case of interference exceeding a positive change of 20 mV, the Contractor shall carry out the remedial works described in Appendix A.

11.4 Commissioning Survey

The commissioning survey shall include the following tests and measurements, where applicable, to ensure that the structure is protected in accordance with the design criteria, and that all equipment is correctly installed and functioning correctly:

- a) Measurement of structure potential at all test points, both before and after energization of the cathodic protection system.

Notes:

1) Following the application of cathodic protection, the potential level of the structure will change with time owing to polarization and, to ensure the structure potential is in the desired range, it may be necessary to take several potential measurements over a given time.

2) Systems requiring large currents may need to be briefly de-energized to permit potential measurement free of voltage drop error.

3) In tanks containing fluids of relatively high resistivity, it is recommended that "off" potentials are measured to minimize voltage gradient errors for impressed current systems.

b) A check for correctness of polarity of electrical circuits, i.e. positive to anode and negative to structure.

c) A functional test of all test points, to ensure correct installation/operation.

d) Assessment of the effectiveness of the following items:

i) All insulating devices.

ii) The continuity of bonds.

iii) The isolation of the structure from electrical earths and secondary structures in accordance with the design.

iv) Casing insulation.

v) Stray current control equipment.

vi) Structure earthing:

A) fortuitous;

B) deliberate; and

C) alternating current.

e) Measurement of the coating resistance.

f) A check that the anode current distribution is as desired.

g) For impressed current systems, the measurement of back e.m.f. and loop resistance.

h) The current required to provide protection.

i) The voltage output of the impressed current system.

j) A test for interference current flow in bonds.

The survey shall also identify the following:

i) The variation in output current and structure potential with time. The rectifier output voltage may also be recorded.

ii) Locations where future measurements (current, source voltage, structure/electrolyte potential) can be taken to provide a representative view of the operation of the system.

iii) Need for any additional test points or cathodic protection facilities.

Data from the survey shall be recorded and retained for future reference.

Details of tests and testing methods to be carried out during the commissioning periods are given in Section 10. The sequence of tests shall be commenced as soon as possible after commissioning.

11.5 Commissioning Report

The Contractor shall submit a commissioning report to the Company representative at the conclusion of check-out and commissioning.

Records associated with cathodic protection systems shall be kept as historical data for future consideration and action. Records are used to demonstrate that a cathodic protection system is working.

The commissioning report shall include, but does not need to be limited to the following:

- a) Design documentation.
- b) Results of periodic survey checks.
- c) Results of equipment checks.
- d) Agreements made with owners of foreign structures.
- e) Location of any test points added to the system.
- f) Coating materials and application procedures.
- g) Correspondence with regulatory authorities.
- h) Information on and location of stray current facilities connected.
- i) Commissioning objectives.
- j) Description of CP system operation.
- k) Original of all check sheets and discrepancy lists.
- l) Conclusions and recommendations.

12. INSTALLATION OF ELECTRICAL ISOLATION EQUIPMENT

12.1 Introduction

This Clause 12 deals with the procedures to be used when installing the equipment used for electrically isolating pipelines. The procedures are designed to ensure that:

12.1.1 A satisfactory degree of electrical isolation is achieved at the time of installation and that the joint is not damaged so as to cause an accelerated degradation rate with time.

12.1.2 The installed equipment is adequately protected against the effects of stray dc or induced ac voltages. Installed to hazardous area see G3.

12.1.3 There is adequate provision for test leads to allow for field testing and maintenance. Typical arrangements are shown in Fig. 6.

12.1.4 Isolation joints installed at coating/electrolyte changes shall always be bonded in test points, to keep the pipeline electrically continuous when the cathodic protection is operational.

12.1.5 If cathodic protection is to be applied on non-welded pipelines the continuity of the pipeline shall be ensured. This should be done by the installation of permanent bonds over high resistance flanges/couplings, using cables and approved attachment methods.

12.1.6 The continuity of non-welded pipelines under cathodic protection shall be checked, e.g. by potential measurements.

Notes:

1) The buried insulating joints installed on pipelines are occasionally used to open the electric continuity of the pipelines and thus create sections isolated from the rest of the network, when it is desired to:

- measure the electric resistance of pipeline coating;
- locate pipeline coating defects;
- limit the zone of influence of the impressed current systems.

2) The normal state of buried insulating joints installed on pipelines is to be electrically shunted.

The aboveground insulating joints installed on district regulators and service lines must never be shunted. Such aboveground insulating joints are not part of the cathodic protection installations; they are rather part of the passive protection.

12.2 Installation**12.2.1 General**

12.2.1.1 When installed, all equipment items shall be properly supported and aligned so that any forces transferred from adjoining pipe are minimized. This should be considered when equipment locations are selected. The type of equipment chosen shall be suitable for the mechanical forces to be encountered at the chosen site. Isolating devices should not be installed in gas systems at locations where there is likelihood of internal moisture accumulation. When possible, the electrical resistance should be checked immediately before and after installation.

12.2.1.2 Before any work is carried out on or near an isolated flange, the area shall be checked for hazardous atmospheres.

12.2.1.3 To avoid risk of electric shock and the possibility of sparking, it is advisable that insulating joints be crossbonded before being assembled. This precaution is essential for hydrocarbon product lines.

12.2.2 Insulating joints

12.2.2.1 Insulating joints shall be ordered with the weld end preparation conforming to the main pipe laying specifications. The manufacturer's special instructions for installation shall always be followed, particularly when welding in joints with short overall lengths, to ensure that the heat generated does not damage the insulating materials used in the joint construction.

12.2.2.2 The Contractor shall align, install and test insulating joints shown in the drawings. The testing shall include:

- electrical test to verify the insulating of the joint1;
- hydrostatic test in-situ, with the pipeline.

12.2.2.3 The Contractor shall perform this work with proper caution so as not to damage the insulating material during the handling, welding and pipe laying.

12.2.2.4 In no case shall the Contractor carry out welding in the vicinity of an insulating joint without shunting the insulation joint. The shunt shall be removed by the Contractor upon completion of the welding.

12.2.2.5 When welding the joint into the pipeline, the Contractor shall take care to ensure that heat shall not be conducted along the pipe and cause damage to the internal lining or insulation.

12.2.2.6 The buried insulating joint shall be manually coated as soon as possible after installation,

as specified in design specification. The above-ground insulating joints shall be painted as specified in design specification.

1 The resistance across isolating joints shall be measured immediately before welding into the pipeline. The minimum resistance shall be 1 mega ohm (10^6 ohm).

12.2.3 Isolated flange joints

12.2.3.1 Factory pre-assembled types

These are supplied with weld ends and may be installed as described in Subclause 12.2.1.

12.2.3.2 Flange insulation kits

12.2.3.2.1 The assembly of an insulating flange requires particular care to ensure that insulation is not lost due to mechanical failure of the components. Flanges are welded to the pipeline, and the flange insulating materials are supplied as a kit, designed to provide insulation for one flange of a given size and type, for site installation.

12.2.3.2.2 The installation shall take place in clean and dry conditions.

12.2.3.2.3 Flanges on which insulating gaskets are to be installed shall be supplied as matched pairs or reamed on site to ensure correct alignment of bolt holes. The flange faces shall be clean and correctly aligned. Misaligned flanges will result in insulating sleeve damage during assembly or subsequent springing of the pipe. Flange faces shall be square and free of burrs to allow for correct sealing of nuts, bolts, and washers.

12.2.3.2.4 The flange shall be assembled using a very high impedance voltmeter attached across the "open" joint. During assembly, potential difference across the joint must not be lost. It may be necessary to create a potential difference across the "open" joint before commencing assembly.

Note:

Using resistance methods to determine integrity of insulating flanges in the field can produce irrelevant results.

12.2.3.2.5 Insulated flanges shall be assembled and tested before being welded into the pipeline. A voltage of 1500 volt DC shall be applied across the flange assembly for one minute without causing breakdown of the insulation or flash over. Subsequently the resistance across the assembled flange shall be measured and shall be more than 1 mega ohm (10^6 ohm).

12.2.3.2.6 On existing flanges, the bolt-to-pipe resistance shall be measured and the overall effectiveness of the isolated flange determined after cathodic protection has been applied. This can effectively be done by measuring the current through the attached pipe using a "Swain-type" current clamp/meter.

12.2.3.2.7 Insulated flanges shall be protected against ingress of dirt and moisture by the application of flange protectors or protective tape, except when used in sour service conditions.

12.2.3.2.8 The isolating gasket shall be carefully aligned between the flange faces and the bolt holes. It may be easier to use one size smaller diameter, high tensile steel bolts, and/or special thin-walled sleeving to assist alignment.

12.2.3.2.9 Alignment pins shall be inserted to ensure that flange alignment is maintained during the installation of the isolating sleeves.

12.2.3.2.10 The isolating sleeves are then positioned in the correctly aligned holes. Isolating

sleeves must be of the correct length. If they are too long, they may be damaged when the bolt nuts are finally tightened. If they are too short, they may fail to isolate properly. The length of the isolating sleeve shall normally include the two isolating washers, except where alignment allows only one flange to be isolated.

12.2.3.2.11 The bolts, complete with isolating washers and steel washers under the bolt and nut heads, are threaded through the sleeves and hand tightened.

12.2.3.2.12 Final tightening to the tension recommended for the diameter and pressure rating of the flange shall be done in a sequence that provides for equal tensioning without distortion.

12.2.3.2.13 The original alignment pins may then be removed and bolts installed, complete with sleeves and washers as described above.

12.2.3.2.14 Complete flanges shall be coated in accordance with design specification.

12.2.3.2.15 To prevent the failure of the insulating materials and to obtain a satisfactory insulating job with a minimum of effort, the following precautions should be observed in installing insulating flanges:

- 1) Micarta washers should be placed next to the flange and topped by steel washers which rest beneath the nut.
- 2) All micarta washers should be placed on the same half of the flange.
- 3) A back-up wrench should be placed on the nut nearest the micarta washer and all tightening of the flange bolt accomplished by turning the nut on the opposite half of the flange.
- 4) The micarta sleeve is designed to extend through both washers. Precautions should be taken to see that it remains in this position during installation work.
- 5) Micarta sleeves should never be hammered or forced into place.

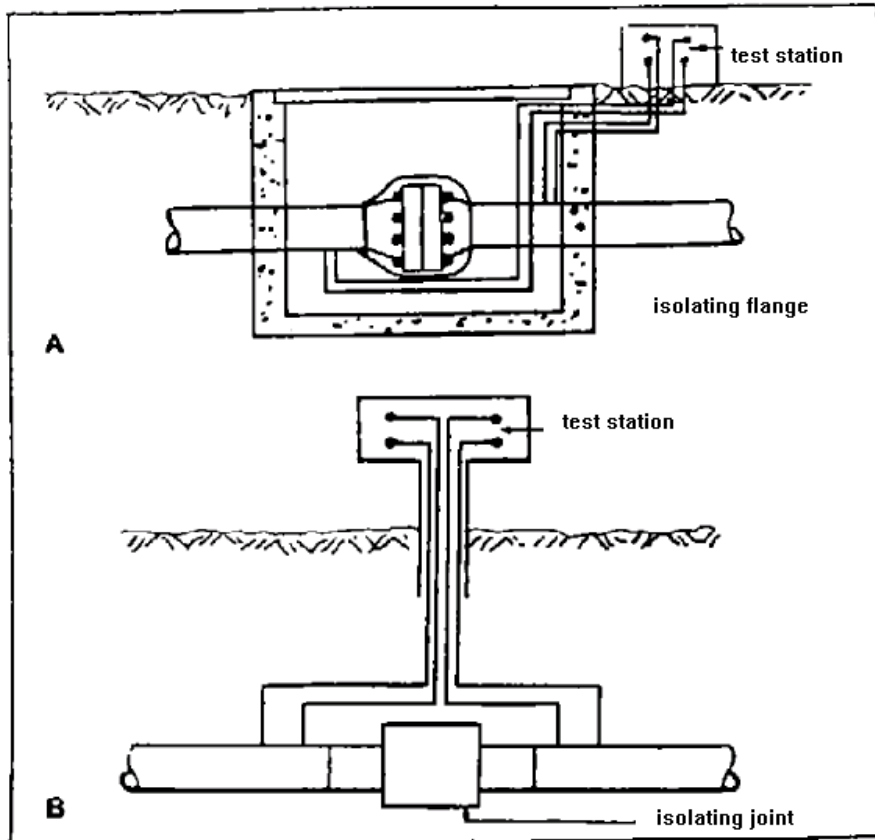

TYPICAL TEST STATION INSTALLATIONS. (A) ISOLATING FLANGE IS OVERWRAPPED TO PREVENT INGRESS OF MOISTURE. THIS BASIC INSTALLATION ALLOWS POTENTIAL MEASUREMENTS TO BE TAKEN ON EITHER SIDE OF DEVICE. (B) INNER CABLES ARE LARGE CROSS SECTION AND ALLOW FOR RESISTANCE TO BE BONDED ACROSS JOINT AS REQUIRED. OUTER CABLES ARE FOR POTENTIAL MONITORING. TO ALLOW EASY IDENTIFICATION, CABLES SHALL BE PERMANENTLY IDENTIFIED

Fig. 6

12.2.3.3 Protection against external moisture ingress

12.2.3.3.1 The materials used for the isolating sleeves and washers may absorb water, and the construction of the joint may allow for moisture ingress, both of which will result in a reduction of the electrical resistance of the assembly. It is therefore essential to provide a protective coating. A suitable material may be applied to fill in the crevices and gaps between flange faces, and to mold around the flange faces so that a smooth profile is achieved which, together with the adjacent pipework, may be coated or wrapped to the same standard as the pipeline. Other methods and materials may be used to protect against moisture ingress.

12.2.4 Pipeline casing insulators

12.2.4.1 Pipeline casing insulators shall be installed in accordance with the manufacturer's instructions. Special care shall be taken to ensure that all subcomponents are correctly assembled and tightened and that no damage occurs during carrier pipe insertion and tightening.

12.2.4.2 The annulus between the carrier pipe and the casing shall be sealed at each end of the casing by means of casing end seals to prevent water from entering the casing.

12.2.4.3 There must be no inadvertent metallic contact between the casing and the carrier pipe. The spacing of insulators shall ensure that the carrier pipe is adequately supported throughout its length, particularly at the ends, to prevent settling and possible shorting.

12.3 High Voltage Protection

12.3.1 Isolating devices and supports shall be protected against damage from high voltage surges. These surges may be caused by lightning, induced AC from adjacent or overhead high tension cables, or fault conditions.

12.3.2 High voltage surges may permanently damage the isolating materials used in the joint construction.

12.3.3 Isolating devices and supports may be protected with lightning arrestors, electrolytic grounding cells, polarization cells, or combinations of these.

12.3.4 The manufacturer's instructions should be followed strictly when installing protective devices. In particular, they shall be physically secured and the connection cables properly sized.

12.3.5 The threshold rating of the protective device shall be such that, even allowing for tolerances, the potential applied across the isolating device is below its minimum dielectric strength.

12.3.6 Lightning arrestors and other protective devices may need to be carefully located or housed to prevent dirt and moisture from collecting, which could lead to an external flashover at a relatively low surge voltage. Applicable electrical codes shall be consulted.

13. THERMIT WELDING OF CATHODIC PROTECTION LEADS

13.1 Introduction

This Clause 13 covers the connection of cathodic protection wire leads to new or in-service carbon steel pipelines under pressure by thermit welding. Connections to pipe less than 3 mm thick shall be made using approved clamps or silver soldering.

13.2 General

13.2.1 For the purposes of this Standard, thermit welds, thermowelds and cadwelds are synonymous.

13.2.2 Thermit weld process shall be applied only by skilled experienced field personnel.

13.2.3 Thermit welds shall not be made on internally plastic coated pipelines. Internal coatings affected include epoxies, phenolics, nylon, polyethylene liners, etc.

13.2.4 The thermit weld charge shall be limited to Thermoweld Cartridge No. 15 F33 (15 gram), or equivalent. **13.2.5** The maximum size of the electrical conductor shall be 25 Sq.mm (No. 6 AWG). Where the attachment of a larger conductor is required, a multistrand wire shall be used and the strands shall be arranged into groups no larger than 25 Sq.mm (No. 6 AWG) and each group attached to the pipe separately.

13.2.6 The minimum distance of a thermit weld from a circumferential weld shall be 200 mm.

13.2.7 The minimum distance of a thermit weld from a longitudinal weld shall be 40 mm.

13.2.8 In attaching one wire to a pipeline only one charge shall be used. If the first thermit weld does not take, a second thermit weld shall not be attempted on the same spot.

If a thermit weld is disapproved on the first charge, it shall either be removed, the surface cleaned to bright metal and the process is repeated or a new location on the pipe is selected.

13.2.9 The permissible operating pressure in the pipeline when thermit welding is shown in Table 1. If the pipe on which the thermit weld will be attached is not in the table, the permissible operating pressure can be calculated using the following formula:

$$P_p = \frac{2S(t - 1.59) \times 0.72 \times 10^3}{D}$$

P_p = Permissible "hot work" pressure (Kpa).

S = Specified minimum yield strength of the pipe (MPa).

D = Nominal outside diameter of the pipe (mm).

t = Nominal wall thickness of the pipe (mm).

Note:

S, D, and t values are to be obtained from the operating permits for the pipeline.

13.2.10 Thermit welds shall not be attached to pipe wall thicknesses less than 3.18 mm while the pipeline is pressurized.

13.2.11 The connection of leads to high pressure gas lines with wall thickness less than 4.78 mm, but more than 3.18 mm by thermit welding shall be done with the gas flowing.

13.2.12 The use of thermit welds shall be avoided in high stress areas such as elbows, tees, etc.

13.2.13 If more than one weld is required such as two adjacent wires or large conductor split in two to get the required size for a 15 gram charge, the spacing between point of connection shall not be less than 100 mm (4 inches).

A suitable copper sleeve for smaller size wire shall be used for a 15 gram one shot mold and the wire bended around the end of the sleeve.

13.3 Pipe Preparation

13.3.1 The pipeline coating shall be completely removed including primer and the pipe cleaned with a file to white metal. The pipe shall be completely dry.

13.3.2 The wall thickness of the pipe shall be checked using a portable ultrasonic wall thickness tester and the permissible pressure of the line checked.

13.3.3 Where possible thermit welds shall be applied to horizontal pipes.

13.4 Thermit Weld Preparation and Procedure

13.4.1 Care shall be taken to ensure that the graphite thermit weld mold is completely dry and free from slag or other impurities before proceeding with thermit welding on pressurized pipelines.

13.4.2 The copper conductor shall be clean and dry and the insulation cut back sufficiently for insertion into the mold.

13.4.3 The copper conductor shall be wrapped around the pipe at least once and enough slack provided to allow for pipe in soil movement.

13.4.4 The thermit welding shall be done in accordance with the steps indicated in the IPS drawing No. IPS-D-TP-702.

13.4.5 After the completion of the thermit weld on buried pipelines, the bright metal surfaces shall be protected and covered by the application of a P.E. tape & primer and a "Royston Handy Cap" or equal. The "Handy Cap" shall be taped in place using primer and cold applied self adhesive P.E. tape to provide a watertight seal on all exposed steel and copper surfaces.

The tape shall overlap existing pipe coating to about 25 mm (1 inch) minimum.

Manufacturer's instruction for application of "Handy Cap" shall be rigidly followed.

TABLE 1 - PERMISSIBLE HOT WORK PRESSURE WHILE THERMIT WELDING

NPA	GRADE		SPECIFIED MINIMUM YIELD		O.D.		W.T.		PERMISSIBLE HOT WORK PRESSURE	
	CSA	API	MPa	PSI	mm	inch	mm	inch	kPa	psig
2	207	A	207	30000	60.3	2.375	3.91	0.154	11 529	1 664
	241	B	241	35000	60.3	2.375	3.18	0.125	9 170	1 330
3	241	A	241	35000	88.9	3.500	3.18	0.125	6 205	900
	290	X42	290	42000	88.9	3.500	4.78	0.188	15 059	2 169
4	241	B	241	35000	114.3	4.500	3.18	0.125	4 826	700
	290	X42	290	42000	114.3	4.500	4.78	0.188	11 713	1 687
6	207	A	207	30000	168.3	6.625	4.78	0.188	5 678	818
	241	B	241	35000	168.3	6.625	4.78	0.188	6 610	955
	290	X42	290	42000	168.3	6.625	3.18	0.125	3 930	570
8	207	A	207	30000	219.1	8.625	5.56	0.219	5 427	783
	241	B	241	35000	219.1	8.625	8.18	0.322	10 486	1 516
	290	X42	290	42000	219.1	8.625	4.17	0.164	4 977	722
10	241	B	241	35000	273.1	10.750	6.35	0.250	6 077	879
	317	X46	317	46000	273.1	10.750	5.56	0.219	6 668	964
	317	X46	317	46000	273.1	10.750	4.78	0.188	5 308	770
12	290	X42	290	42000	323.9	12.750	6.35	0.250	6 166	889
	317	X46	317	46000	323.9	12.750	6.35	0.250	6 740	974
	359	X52	359	52000	323.9	12.750	4.78	0.188	5 060	734
14	290	X42	290	42000	355.6	14.000	6.35	0.250	5 616	810
	317	X46	317	46000	355.6	14.000	5.59	0.219	5 122	743
16	317	X46	317	46000	406.4	16.00	6.35	0.250	5 372	776
	359	X52	359	52000	406.4	16.00	5.59	0.219	5 067	735

Note:

The wall thickness of the pipe to be worked on is to be checked with an Ultrasonic Wall Thickness Tester after the pipe has been cleaned for welding. The thermit weld is not to be made on a pitted or laminated pipe or where the wall thickness is less than 90% of nominal pipe wall thickness.

APPENDICES**APPENDIX A
CONTROL OF INTERFERENCE CURRENTS ON FOREIGN STRUCTURES****A.1 General**

A.1.1 Interference from cathodic protection systems arises where a foreign structure intersects the direct current path between the anode and cathode. Where the current enters the structure the effect is cathodic. Where it leaves the structure the effect is anodic, and the rate of corrosion at that position may be increased.

A.1.2 Interference may be detected by a change in the potential of the foreign structure when the system current is interrupted. The result of this test indicates whether the foreign structure is being subjected to an increased or a decreased corrosion hazard.

A.1.3 Where a foreign structure is sited adjacent to a protected immersed structure, but not electrically bonded to it, interference can occur. Two common foreign structure types are as follows:

- a) A discrete movable structure, such as a moored ship.
- b) A buried or immersed pipeline or metal sheathed cable adjacent to the protected structure or its anode system.

A.1.4 Galvanic anodes used in immersed systems do not usually cause interference to other structures.

A.1.5 Interference problems are more probable with impressed current systems because of the electrolyte voltage gradients usually associated with the anodes.

Note:

When marine structures are cathodically protected, adequate precautions shall be taken to avoid interference effects when using impressed current and also to ensure that danger does not arise through the production of sparks when ships, barges, etc., make or break electrical contact with the protected structure.

Marine conductors (protective pipes through which wells are drilled) are often closely packed in the conductor bay area. Care shall be taken that adequate current densities are available for the protection of the marine conductors. Full electrical continuity may not always be provided and special measures may be required to ensure this.

Electrical interference effects are negligible with sacrificial-anode systems, as these anodes are placed much nearer to the protected structure than to any unprotected steelwork and because their driving voltage is usually much lower than that of impressed-current system groundbeds.

A.1.6 Telluric current and induced alternating currents can be of particular importance on transmission pipelines. The effects and remedies are dealt with in Clauses A.7 and A.8.

EXAMPLE OF CURRENT PICK-UP BY NEIGHBORING STRUCTURE FROM CATHODIC PROTECTION SYSTEM

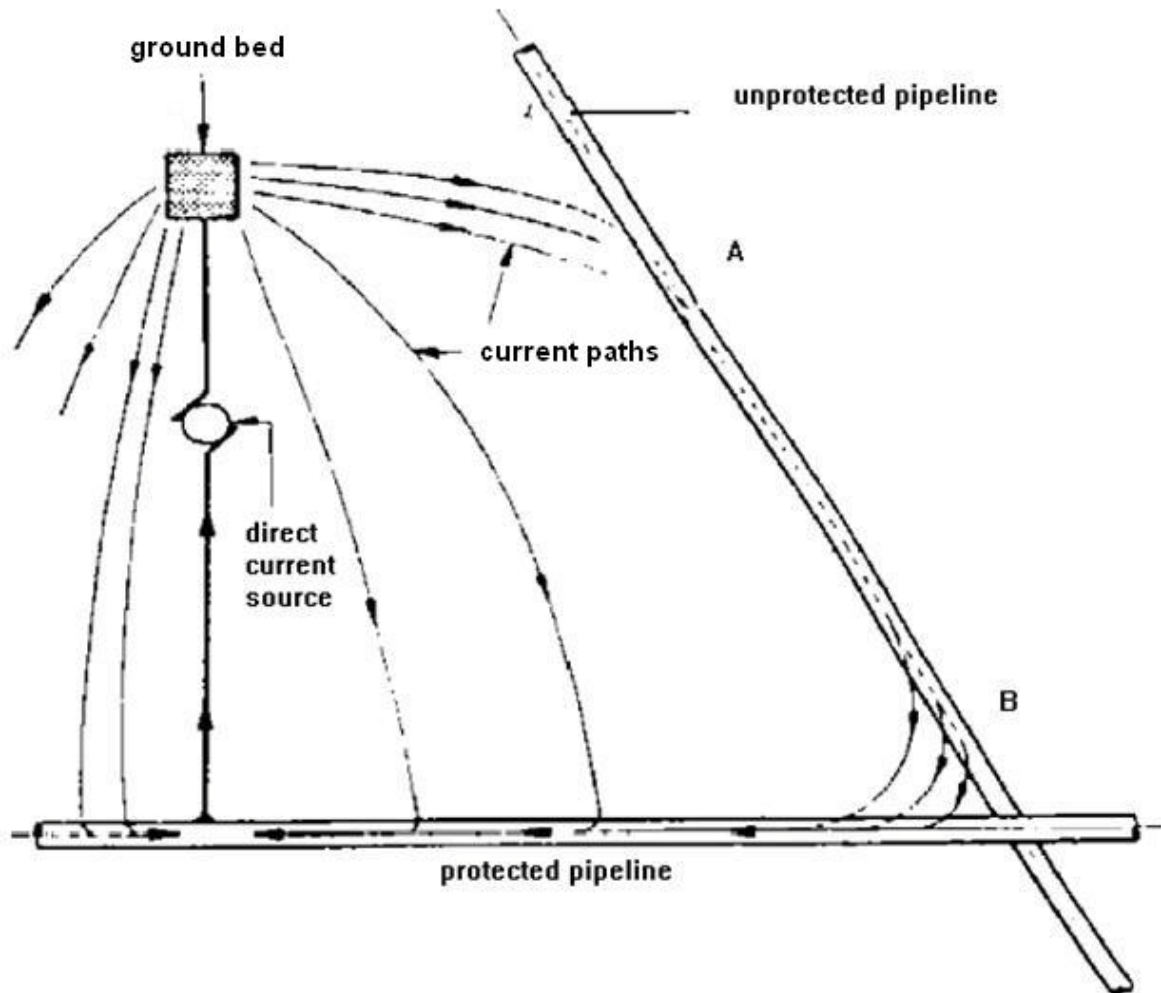

THE UNPROTECTED PIPELINE BECOMES CATHODIC AT THE POINT WHERE THE CURRENT IS PICKED UP (A), AND ANODIC AT THE POINT WHERE THE CURRENT EVENTUALLY LEAVES THE LINE (B), RESULTING IN PROTECTION AT 'A' AND CORROSION AT 'B' SINCE POINT 'B' BECOMES ANODIC, THE PIPE-TO-SOIL POTENTIAL MEASURED WITH A COPPER/COPPER SULPHATE ELECTRODE BECOMES MORE POSITIVE WHEN THE RECTIFIER IS SWITCHED ON. A CHANGE TO POSITIVE IN POTENTIAL OF MORE THAN 50 MILLIVOLTS WHEN THE RECTIFIER IS SWITCHED FROM 'OFF' TO 'ON' INDICATES AN OBJECTIONABLE DEGREE OF STRAY CURRENT CORROSION

Fig. A.1

A.2 Notifying Owners of Other Structures for Interference Testing

A.2.1 It is essential, throughout the installation, testing, commissioning and operation of a cathodic protection system, that notice of actions proposed be given to all organizations and owners having buried metallic pipes, cables or other structures in the near vicinity of the installation.

These notices are intended to ensure that information becomes available to enable a system to be installed in such a manner that interference is kept to a minimum and that enough information is given to other organizations to enable them to determine whether corrosion interference is likely.

A.2.2 After commissioning tests of the system have been completed, notification shall be sent to all organizations who have indicated that they have structures likely to be affected by the operation of the system. The following information should be supplied at least one month before the date proposed for interference tests:

- a) The anticipated current at which each rectifier or sacrificial anode will be operated during interference tests;
- b) An indication of structure/soil potentials along the primary structure before and after the application of protection;
- c) Dates for the tests.

At the time of the tests, there shall be available to all participants, suitably scaled plans showing the layout of the primary and secondary structures at the test locations together with the locations of the cathodic protection installations, drawn up from information supplied by both the operator and the other interested parties.

A.2.3 If, at any time after the cathodic protection system has been brought into regular service, it is found necessary to alter the system substantially, details of the proposed amendments should be sent to all organizations having buried metallic structures near the revised cathodic protection system.

A.3 Interference Testing

A.3.1 Stage at Which Interference Tests shall be Made

At least one month shall be allowed, if required, for the owners of nearby structures to examine details of the proposed system and to respond so that the operator may arrange for interference tests. Tests shall be made within three months of switching on the cathodic protection.

A.3.2 Tests to assess interference

The changes in structure/electrolyte potential due to interference will vary along the length of the secondary structure and a negative potential change at any point will often indicate the presence of positive changes at other parts of the structure. For most metals, only positive potential changes are liable to accelerate corrosion. The usual object of interference testing is, therefore, to find the areas where the potential change is positive, to locate, by testing a number of positions, points at which the potential change locally reaches a maximum and to assess each maximum value with sufficient accuracy. In the case of discontinuous structures (such as mechanically jointed pipelines) it is essential that each discontinuous section shall be treated as a separate structure for testing.

Quantitative assessment of probable damage is difficult because any current discharge from a foreign structure is difficult to measure, and the surface area from which it discharges is difficult to estimate, particularly in built-up metropolitan areas where there is a multitude of underground services. The extent of foreign structure testing therefore depends on a number of factors, including the following:

- a) The relative positioning of the protected structure and foreign structures.
- b) Soil resistivity variations.
- c) Electrical conductivity per unit length of all structures concerned.
- d) Anode current.
- e) Condition of coatings on all structures concerned.

Field experience and application of the above factors enables estimation of the likely degree of interference, and the extent of foreign structure testing required. The interference caused by the electrical gradient around the protected structure usually only extends for a radial distance of a few meters from the structure. However, the extent of interference caused by the electrical gradient field around the anode may extend for some hundreds of meters, with the result that foreign structures up to a kilometer or more away may be affected.

In certain cases, negative changes of potential in excess of the level that would be needed for cathodic protection may adversely affect the structure or its coating. The current used for the test shall be the maximum required during normal operating conditions to give the level of protection required on the protected structure. A test current below the anticipated current required during normal operation may not bring about the maximum changes in potential on secondary structures. The criterion is the magnitude of the change of potential of the secondary structure (see Note) with respect to its electrolytic environment that occurs when the cathodic protection is switched on or when the sacrificial anodes are connected. This change is usually equal in magnitude to, but has

the opposite sign from, the change occurring when the protection is switched off.

Note:

When, as is normally the case, the positive terminal of the meter is connected to the reference electrode, the potentials measured are usually negative and a change in the positive direction will be indicated by a reduction in the meter reading.

The change recorded shall be that change clearly seen to be due to the switching on of the cathodic protection unit, not more than 15 s being allowed for the instrument to indicate the resulting change of structure electrolyte potential before the reading is taken. If there are also fluctuations of potential due to the effects of stray currents from other sources, then only those changes caused by the switching on of the cathodic protection unit shall be recorded. Several observations shall be made at each point and compared. In marginal cases, the number of observations shall be increased and examined for consistency. This is of particular importance at positions where tests indicate that the changes in the positive direction on the secondary structure are locally at a maximum. The position of the reference electrode is often important. It is important to synchronize the measurement of structure/electrolyte potential with the switching. This can be done by providing radio, or other, communication between the individual who is making the actual measurement and the one who is controlling the cathodic protection unit, the cathodic protection being switched on and off alternately by hand. Alternatively, the cathodic protection unit can be switched on and off at agreed regular intervals by means of a suitable time-switch. The change in structure/electrolyte potential resulting from the cathodic protection shall be measured at a sufficient number of points, generally working outward from the anode of the protection system, and with the spacing being sufficiently close, to give an overall picture of the distribution of structure/electrolyte potential change. Detailed attention shall be given to crossing points or points of close proximity between the primary and secondary structures and to regions where the change produced has been found to be in the positive direction. Where more than one cathodic protection unit is installed on a particular structure, the combined effect shall be ascertained. Arrangements shall be made for all units which cause an appreciable effect at the position of tests, to be switched on and off or connected and disconnected simultaneously.

The protection current measured at each rectifier during interference tests, and the finally agreed currents to be employed as a result of any remedial measures, should be notified to all organizations attending the tests and all authorities who have indicated that they have structures likely to be affected by the operation of the system.

A.3.3 Tests after remedial measures have been applied

Further testing may be required after agreed remedial measures have been applied. If, after providing bonds between two structures or fitting sacrificial anodes in order to reduce interference, the structure/electrolyte potential of the secondary structure is found to be appreciably more negative than that measured with the cathodic protection switched off during the initial interference testing, this will normally be sufficient indication that the mitigation procedure is achieving its purpose. The criterion shall be the change of the structure/electrolyte potential between the original condition with the cathodic protection switched off and the final remedied condition with the cathodic protection operating, switching and bonding or anode connection being carried out quickly to minimize any effects of variations from other sources.

It may happen that the initial structure/electrolyte potential of the secondary structure is more negative than the potential of the primary structure. For example, a galvanized steel structure without applied cathodic protection, even when its structure/electrolyte potential is changed in the positive direction due to the effect of a nearby cathodic protection system, may be more negative than a cathodically-protected lead or ungalvanized steel structure. Under these circumstances, an adverse effect cannot easily be offset by bonding since, owing to galvanic action between the primary and secondary structures, the structure/electrolyte potential of the latter would be made more positive, the effect being larger than any beneficial effect due to the cathodic protection. Bonding could be made effective only by making the primary structure more negative, for example, by increasing the total protection current or moving one of the groundbeds closer to the point where it is proposed to bond. Alternatively, the secondary structure could be protected by a separate cathodic protection system, possibly by installing sacrificial anodes connected to the secondary

structure. In exceptional cases it may be found possible, by special agreement between the parties, to accept structure/electrolyte potential changes on the secondary structure greater than the accepted normal limit and thereby avoid the need for remedial action.

A.4 Criteria for Limiting Corrosion Interaction

A.4.1 General

Any current flow that makes the potential of a metal surface more positive with respect of its surroundings is liable to accelerate corrosion. The structure/electrolyte potential is therefore used as the basis of assessment. Positive structure/ electrolyte potential changes are the more important.

A.4.2 Limit of positive structure/electrolyte potential changes for all structures

The maximum positive potential change at any part of a secondary structure, resulting from interference, shall not exceed 20 mV. Subsequent experience has provided no indication that corrosion damage occurs when this limit is respected. However, in many circumstances, particularly if the existing conditions provide a measure of cathodic protection at the relevant part of the structure, higher potential changes could be tolerated.

Some structures are inherently more resistant to stray currents. For example, for cables having a good extruded-plastics coating, the danger of damage to the coating in making test connections for interference testing is probably a greater risk than that due to interference. Any interference associated with cable systems is likely to be manifested at the nearest earthing facility. Should the secondary structure be provided with independent cathodic protection, then the owners of the secondary structure may agree to accept a greater positive potential change on this structure, provided that its potential remains more negative than the value given in protection criteria.

A.4.3 Negative changes of structure/electrolyte potential

Large negative changes may, however, occur if the groundbed of an impressed current cathodic protection system is unduly close to a secondary structure. Structure/electrolyte off potentials more negative than -1.2 V shall be avoided on buried structures.

A.5 Control of Interference

A.5.1 General

Where testing of a cathodic protection installation indicates that there is interference at a level which may result in corrosion of the foreign structure, control of the interference may be achieved by taking the following actions:

- a) Installing galvanic anodes or an impressed current system on the foreign structure.
- b) Bonding the foreign structure to the primary structure through a current controlling resistance, if appropriate.
- c) Insulating the foreign structure.
- d) Using distributed cathode points to reduce the average potential shift on a poorly-coated protected structure.
- e) Relocating foreign structures away from the interfering field.
- f) Reducing the cathodic protection system current.

Where the foreign structure is electrically discontinuous, as may occur on a cast iron pipeline with elastomer ring joints, some bonding of the high resistance joints may be necessary before the above measures can be adopted.

In practice, it is sometimes found that reducing the system current can reduce the interference on foreign structures to a level acceptable to all concerned, while maintaining a satisfactory level of protection on the protected structures.

A.5.1.2 Mitigation of interference on a fixed immersed foreign structure is generally achieved by either bonding the two structures, or by installing a separate cathodic system on the foreign structure to protect it in its own right.

With a discrete movable foreign structure, such as a ship berthed at a cathodically protected steel-piled wharf, bonding is usually avoided because of the following factors:

- a) A movable structure will usually have its own cathodic protection system.
- b) A movable structure is usually well coated; when bonded to a large fixed immersed structure system, excessively negative potentials may result on the movable structure, causing coating disbondment.
- c) A movable structure will normally only remain near the fixed immersed structure for a short period, i.e. during loading and unloading, and as a result the total interference effect is minimal.
- d) The making and breaking of temporary bond connections may result in the generation of sparks or arcs which can be hazardous at installations handling flammable materials.

A.5.2 Control by the use of galvanic anodes

Interference may be controlled by installing galvanic anodes on the foreign structure, to make the potential at least as electro-negative as that which existed prior to the interference.

Note:

Advantages and disadvantages of this method are as follows:

- a) **Advantages:**
 - i) **The owner of the foreign structure has control over the anodes, and thus can be assured of their continued operation.**
 - ii) **Galvanic corrosion or problems arising from complex stray currents shall not occur.**
- b) **Disadvantages:**
 - i) **If interference is great, the foreign structure is bare or the soil is of high resistivity, the limited driving voltage of the galvanic anodes may not provide sufficient protection current.**
 - ii) **The performance of the anodes requires to be monitored.**
 - iii) **Galvanic anodes sited in areas where there are steep potential gradients resulting from a foreign cathodic protection system, may accentuate the pick-up of stray current which may discharge at the remote side of the structure, and cause corrosion.**

A.5.3 Control by the use of impressed current cathodic protection

In special circumstances, interference can also be controlled by installing impressed current cathodic protection on the foreign structure.

Note:

Advantages and disadvantages of this method are as follows:

- a) **Advantages:**
 - i) **The owner of the foreign structure has control over the anodes, and thus can be assured of their continued operation.**
 - ii) **Galvanic corrosion or problems arising from complex stray currents shall not occur.**
 - iii) **If interference is significant, the foreign structure bare, or the soil resistivity high, the high driving voltage of impressed current cathodic protection may be required to provide adequate protection.**
 - iv) **In stray current areas, an impressed current cathodic protection system is less likely to accentuate stray current pick-up than a galvanic system.**
- b) **Disadvantages:**
 - i) **Interlocks between the interfering cathodic protection system and the second cathodic protection system may be required to control adverse effects shall failure of the first cathodic protection system occur.**
 - ii) **The interference suppression current will require to be monitored for proper operation.**

- iii) Power supplies for the transformer/rectifier may be difficult to arrange at isolated locations.
- iv) The impressed current interference suppression system may itself cause additional interference, and it may require registration with, or approval by, the relevant Authority.

A.5.4 Control by bonding

Interference may be controlled by bonding the foreign structure to the primary structure, or by connecting the foreign structure directly into the impressed current cathodic protection system. In the former case, an appropriate resistor is inserted in series with the bond to control the current flow to the level required to just offset interference. In the latter case, a diode and a resistor are inserted into the impressed current circuit.

Diodes are used to prevent the following problems from occurring:

- a) Where the foreign structure and the primary structure are of dissimilar metals, interruption to the cathodic protection current can lead to galvanic corrosion.
- b) Where structures are located in a stray current area, current flow from one structure to the other can affect the overall stray current flow.

Notes:

- 1) This is particularly important where stray current drainage from more than one structure is involved.
- 2) Advantages and disadvantages of the bonding method are as follows:

a) Advantages:

- i) It is an economical solution where the structure access points are close together.
- ii) The existing bond may be capable of automatically coping with an increase in output of the cathodic protection unit.

b) Disadvantages:

- i) Where the foreign structure is remote from the cathodic protection installation, bonding may lead to galvanic corrosion and stray current problems shall failure of the cathodic protection system occur.
- ii) The owner of the foreign structure does not have control of both ends of the bond.
- iii) The bond requires monitoring to ensure it is not accidentally broken, cut, disconnected or fused.

Before bonds are installed, approval must be obtained from the affected parties.

A.6 Fault Conditions in Electricity Power Systems in Relation to Remedial and/or Unintentional Bonds

There is a possible risk in bonding a cathodic protection system to any metalwork associated with the earthing system of an electricity supply network, whether by intention or not. This is particularly important in the vicinity of high-voltage sub-stations.

Bonds between metalwork associated with an electricity power system (e.g. cable sheaths) and cathodically-protected structures, can contribute an element of danger when abnormal conditions occur on the power network. The principal danger arises from the possibility of current flow, through the bonds, to the protected structure, due to either earth-fault conditions or out-of-balance load currents from the system neutral.

The current, together with the associated voltage rise, may result in electric shock, explosion, fire or overheating and also risk of electrical breakdown of coatings on buried structures. Such hazards shall be recognized by the parties installing the bond and any necessary precautions taken to minimize the possible consequences. The rise in temperature of conductors is proportional to i^2t , where i is the fault current and t its duration. Conductors, joints and terminations shall be sufficiently

robust, and of such construction, as to withstand, without deterioration, the highest value of i^2t expected under fault conditions. For extreme conditions, duplicate bonding is recommended. Precautions shall also be taken against danger arising from the high electro-mechanical forces which may accompany short-circuit currents.

It is difficult to ensure that current-limiting resistances comply with the foregoing requirements; their insertion in bonds through which heavy fault current might flow shall therefore be avoided as far as possible. If they are used, it is essential that they be carefully designed for the expected conditions. Bonds and any associated connections shall be adequately protected from damage or deterioration.

A.7 Telluric Current

A.7.1 Geomagnetic field variations associated with the ionospheric currents establish large-scale systems of electric currents within the earth by a process of electromagnetic induction. The global pattern of these currents flowing near the surface of the earth is known to be extremely complex due to factors such as the wide range of electrical conductivities of different strata.

A.7.2 The frequency of the fluctuations has been recorded to be a matter of one per several hours.

A.7.3 A pipeline of considerable length being positioned favorably can pick-up and discharge telluric currents. If the current picked-up is considerable in comparison with the total current applied for corrosion prevention (which can be the case with a very well-coated pipeline in high-resistivity soil) the effect of telluric current on such a system will become noticeable and may have to be corrected.

A.7.4 A number of countermeasures can be taken to combat ill effects from telluric currents. Sectioning the line by insertion of insulation flanges or joints will reduce long line current flow. Installation of discharge points by providing zinc or magnesium anodes at strategic locations will reduce the risks of corrosion at discharge of current at coating imperfections.

A.7.5 It is strongly recommended to obtain expert advice if a case is found suspect.

A.8 Alternating Current Effects

A.8.1 Alternating currents induced in pipeline systems running parallel with power lines especially, have no influence on the corrosion of the cathodically protected lines but can generate voltages that require mitigation.

A.8.2 It is not uncommon that pipelines and power transmission systems share a right of way. Rules and regulations exist for guidance on earthing of the power transmission system and the distances to be maintained between these and the pipeline(s) in question.

A.8.3 If routing the pipeline close and parallel to an overhead high-voltage system cannot be avoided, a study should be conducted by experts to determine which sections of the pipeline are influenced by a short circuit to earth and to what extent. For more information see NACE-SP-0177.

A.8.4 Some of the main distances that should be maintained are:

- During the construction of a pipeline, it should be separated from the vertical projection of the nearest highvoltage line by at least 10 m for safety reasons;
- Valve stations, safety releases, etc., projecting above the ground are not to be installed within 30 m;
- Between the pipeline and the earthing pit of the transmission tower the minimum distance shall be additional 3 m for a max. earth-fault current of 5 kA, plus 0.5 m for every additional kA.

A.8.5 Special attention shall be paid to the cathodic protection of pipelines and the overvoltage protection for rectifiers:

- At valve stations a steel net buried around the valve and electrically bonded to the pipelines may be required for the protection of personnel.
- It is generally advisable to discuss special requirements with the local power company or the labor inspectorate; especially during construction of a pipeline restrictive regulations may be imposed by the local power company.

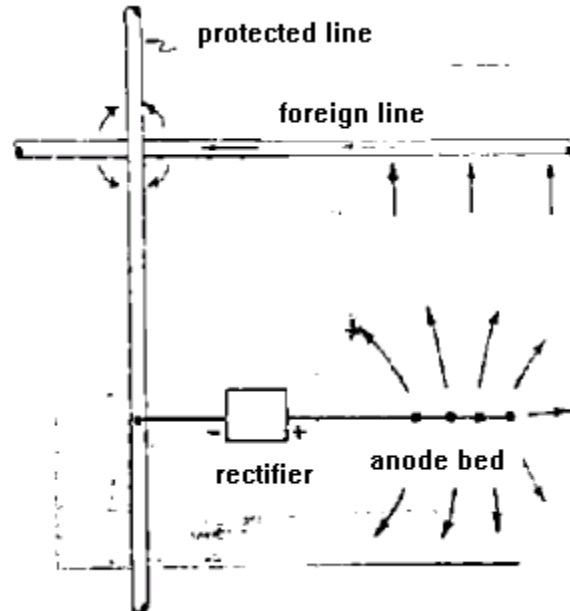

INTERFERENCE. SOME OF THE CURRENT FLOWING FROM THE ANODE BED TO THE PROTECTED LINE COLLECTS ON THE FOREIGN LINE, FLOWS ALONG IT TOWARD THE CROSSING (FROM BOTH SIDES), AND THEN DISCHARGES THROUGH THE SOIL TO THE PROTECTED LINE. DAMAGE IS INFLICTED ON THE FOREIGN LINE IN THE NEIGHBORHOOD OF THE CROSSING.

Fig. A.2

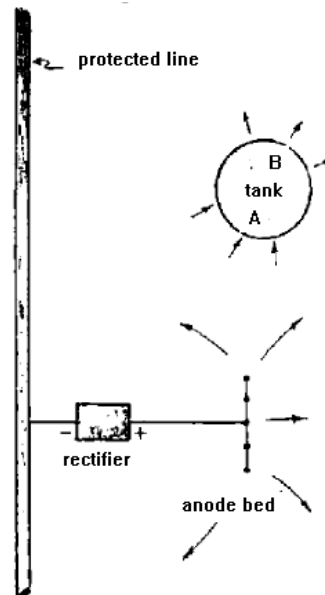

INTERFERENCE (RADIAL CURRENT FLOW). WHEN A STRUCTURE LIES IN A REGION OF HEAVY CURRENT DENSITY, SUCH AS THE TANK SHOWN CLOSE TO THE ANODE BED, IT MAY PICK UP CURRENT AT "A" AND DISCHARGE IT TO EARTH AT "B", WITH RESULTANT DAMAGE AT THE DISCHARGE AREA. SOMETIMES, BUT NOT OFTEN, AN ISOLATED METALLIC STRUCTURE LYING NEAR A PROTECTED LINE CAN UNDERGO THE SAME KIND OF DAMAGE.

Fig. A.3

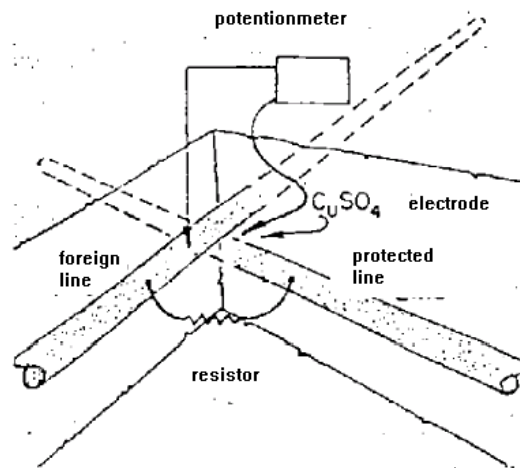

ADJUSTMENT OF CROSSING BOND. THE COPPER SULFATE ELECTRODE IS PLACED BETWEEN THE TWO LINES AT THE POINT OF CROSSING. THE RESISTOR IS THEN ADJUSTED BY TRIAL AND ERROR UNTIL THERE IS NO CHANGE IN THE POTENTIAL OF THE FOREIGN LINE WITH RESPECT TO THE ELECTRODE WHEN THE RECTIFIER IS TURNED ON AND OFF. IT IS HELPFUL TO MEASURE THE "SHORT-CIRCUIT" CURRENT BETWEEN THE TWO LINES FIRST, USING THE "ZERO-RESISTANCE AMMETER" CIRCUIT DIAGRAMMED IN FIG. A.5

Fig. A.4

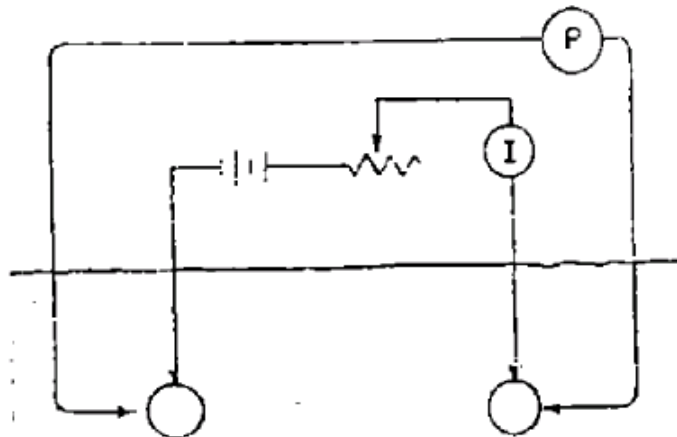

ZERO-RESISTANCE AMMETER. TO DETERMINE THE CURRENT WHICH WOULD FLOW THROUGH A "SOLID" OR ZERO-RESISTANCE BOND BETWEEN TWO STRUCTURES, THE CIRCUIT ILLUSTRATED IS USED. THE CURRENT FROM THE BATTERY IS ADJUSTED UNTIL THE POTENTIOMETER (OR HIGH-RESISTANCE VOLTMETER) READS ZERO. THEN THE CURRENT INDICATED BY THE AMMETER I IS THE SOUGHT FOR VALUE. THERE ARE INSTRUMENTS AVAILABLE WHICH INCORPORATE THIS COMPLETE CIRCUIT WITHIN THEMSELVES

Fig. A.5

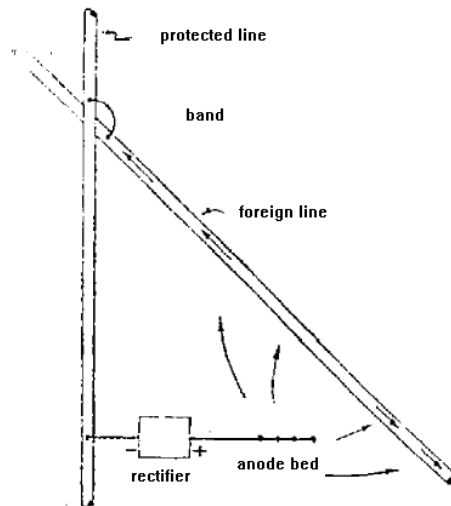

AN OBSCURE CASE. MUCH OF THE CURRENT COLLECTED ON THE FOREIGN LINE FLOWS TOWARD THE CROSSING, WHERE IT CAN BE SAFELY HANDLED WITH A SIMPLE BOND. SOME OF IT, HOWEVER, FLOWS IN THE OPPOSITE DIRECTION AND IS DISCHARGED OVER A RELATIVELY LARGE AND REMOTE AREA. SUCH A SITUATION DOES NOT ARISE OF TEN AND PROBABLY DOES LITTLE DAMAGE IN ANY CASE BECAUSE OF THE LARGE DISCHARGE AREA. IT CAN BE AVOIDED BY PROPER ANODE BED PLACEMENT AND REMEDIED BY THE USE OF AUXILIARY DRAINAGE ANODES. THE BEST SOLUTION IS THE INSTALLATION OF ONE OR MORE MAGNESIUM ANODES AT THE POINT OF EXPOSURE. THE COLLECTED CURRENT, INSTEAD OF FOLLOWING THE BOND BACK TO THE PROTECTED LINE, FLOWS TO EARTH BY WAY OF THE MAGNESIUM ANODES

Fig. A.6

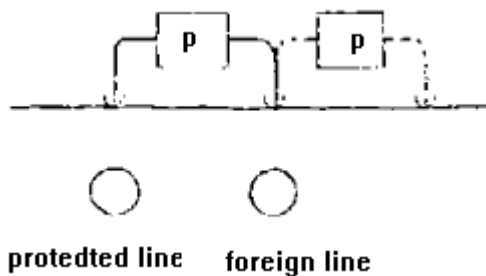

CURRENT TRANSFER BETWEEN PARALLEL LINES. IF THE DELTA (DIFFERENCE BETWEEN ON AND OFF READINGS) IN THE POSITION SHOWN IN SOLID LINES IS APPRECIABLY GREATER THAN THAT IN THE DOTTED POSITION, THEN THERE IS CURRENT TRANSFER FROM THE FOREIGN LINE TO THE PROTECTED LINE. WHEN THE POINT OF WORST EXPOSURE IS LOCATED, A BOND SHOULD BE INSTALLED. A REPEAT SURVEY MUST THEN BE MADE TO DETERMINE THE LENGTH OF SECTION WHICH THE BOND WILL PROTECT, AND OTHER BONDS INSTALLED IF REQUIRED

Fig. A.7

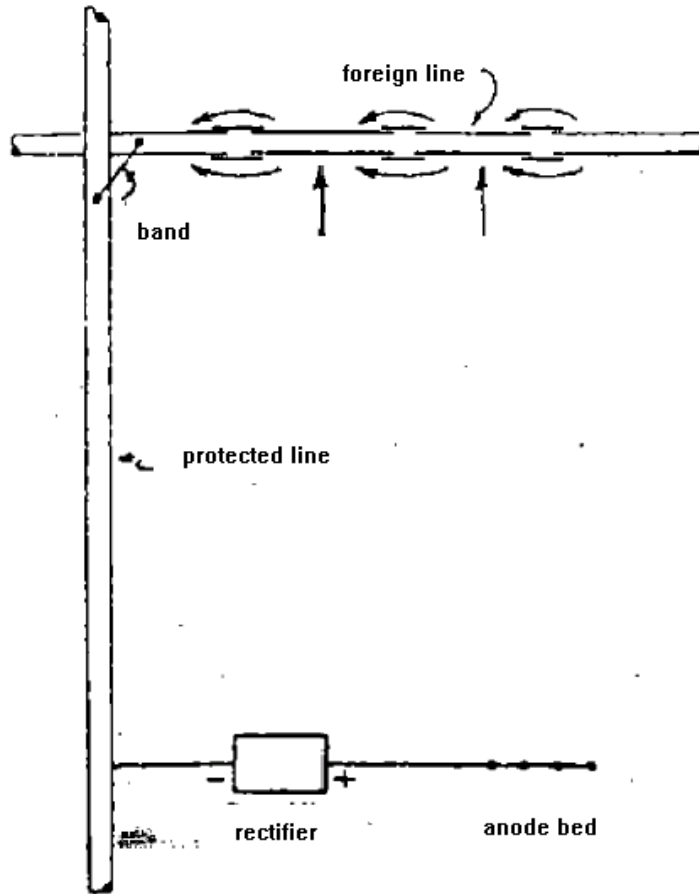

FOREIGN LINE WITH DRESSER COUPLINGS. THE INSTALLATION OF A BOND AT THE POINT OF CROSSING WILL AVERT THE DAMAGE THERE, BUT THERE WILL STILL BE DAMAGE DONE AT THE MECHANICAL JOINTS, BY CURRENT BYPASSING THEM THROUGH THE EARTH. THIS CAN BE REMEDIED BY BONDING THE JOINTS OR BY THE USE OF AUXILIARY MAGNESIUM ANODE DRAINAGE

Fig. A.8

APPENDIX B MEASUREMENT OF SOIL RESISTIVITY

B.1 General

B.1.1 There are a number of methods for measuring soil resistivity (see Fig. B.1), the most common is the "Wenner 4-pin method".

B.1.2 The equipment required for field resistivity measurements consists of a hand-driven earth-tester (vibroground equipment), four metal (mild steel or martensitic stainless steel) electrodes, and the necessary wiring to make the connections shown in Fig. B.1. Terminals shall be of good quality to ensure that low-resistance contact is made at the electrodes and the meter.

B.1.3 The Wenner four-pin method requires that four metal pins be placed with equal separation in a straight line in the surface of the soil to a depth not exceeding 5% of the minimum separation of the pins. Watering in moderation around the pins is permissible to ensure adequate contact with the soil. The pin separation should be selected with consideration of the soil strata of interest. The resulting resistivity measurement represents the average resistivity of a hemisphere of soil of a radius equal to the pin separation.

B.1.4 A voltage is impressed between the outer electrodes, causing current to flow, and the voltage drop between the inner electrodes is measured. Alternatively, the resistance can be measured directly. The resistivity, is then:

$$\begin{aligned}\rho, (\rho \text{ in } \Omega.cm) &= 2\pi aR(a \text{ in } cm) \\ &= 191.5aR(a \text{ in } ft.)\end{aligned}$$

Where:

a = electrode separation, and

R = resistance, Ω .

Using dimensional analysis, the correct unit for resistivity is ohm-centimeter. The depth of the electrodes should not exceed the value $\frac{a}{20}$.

B.2 Field Procedures

B.2.1 Select the alignment of the measurement to include uniform topography over the limits of the electrode span. Do not include large nonconductive bodies such as frozen soil, boulders, concrete foundations, etc., which are not representative of the soil of interest, in the electrode span. Conductive structures such as pipes and cables shall not be within " $\frac{1}{2}$ a" of the electrode span unless they are at right angles to the span.

B.2.2 Select electrode spacings with regard to the structure of interest. Since most pipelines are installed at depths of from 1.5 to 3 m, electrode spacings of 1.5 and 3 m are commonly used. The "a" spacing shall equal the maximum depth of the interest. To facilitate field calculation of resistivities, spacing of 1.58 and 3.16 m, which result in multiplication factors of 1000 and 2000, can be used.

B.2.3 Impress a voltage across the outer electrodes, causing the current to flow. Measure the voltage drop across the inner electrodes and read the resistance directly and record.

B.2.4 Make a record of electrode spacing, resistance, date, time, air temperature, topography, drainage, and indications of contamination to facilitate subsequent interpretation.

B.2.5 It should be recognized that subsurface conditions can vary greatly in a short distance, particularly where other buried structures have been installed. Surface contamination tends to concentrate in existing ditches with surface runoff, appreciably lowering the resistivity below the natural level.

B.2.6 To evaluate contamination effects when a new route is being evaluated, soil samples can be obtained at crossings of existing pipelines, cables, etc., or by intentional sampling using soil augers.

Notes:

1) Other field resistivity measurement techniques and equipment are available. These commonly use two electrodes mounted on a prod that is inserted in the soil-at-grade in an excavation or a driven or bored hole. The two-electrode technique is inherently less accurate than the four-electrode method because of polarization effects, but useful information can be obtained concerning the characteristics of particular strata.

2) Risk and error must be arbitrarily selected to allow determination of the number of measurements. A risk of 5% of an error greater than 100 Ω .cm should be suitable for most situations. The error limit should be about 10% of the anticipated mean resistivity.

B.3 Frequency of Measurement

B.3.1 The frequency of measurement is dependent on the purpose of the soil survey. Common practice for a general pipeline route survey is to record values at an average of 1 km intervals, however, where the purpose is to locate corrosion "hot-spots", measurements every 100-150 m may be necessary.

B.3.2 Where a variation between two successive readings is greater than the ratio 2:1, intermediate readings shall be included.

B.3.3 Where pipelines are existing, measurements are taken to one side of the pipeline and at right angles to it at minimum distance equal to the electrode spacing "a" from the pipeline.

B.3.4 For general pipeline route surveys, it is common to undertake a series of readings covering soil above the pipe, soil at pipe depth, soil immediately below the pipe, i.e. 1/2D, D and 2D where D is depth of the pipe.

B.3.5 For groundbed location surveys it may be necessary to measure to greater depths and spacings of up to say 30 m are recorded depending on the variation of soil resistivity with depth.

B.3.6 In very dry/high resistance surface soils or where large numbers of measurements or measurements to considerable depths may be required (e.g. for deepwell groundbeds) resistivities may be taken using electromagnetic induction techniques.

B.4 Presentation of Results

Results are presented in ohm-cm and graphically with resistivities (log scale) versus distance (linear) for a pipeline route (Fig. B.2). Where resistivities have been taken to various depths the layer resistivity between each depth can be calculated using the "Barnes Method"*.

* See control of pipeline corrosion; A.W. Peabody, P 90-91, NACE.

B.5 Criteria and Interpretation

Soil corrosivity assessment may be based on either one or a number of parameters.

BS 7361 quotes a form of assessment based on resistivity as:

up to 1000 ohm-cm	- severely corrosive
1000 to 10000 ohm-cm	- moderately corrosive
10000 ohm-cm and above	- slightly corrosive

Often a "global index" technique is used and three useful Indices are given in Table B.1.

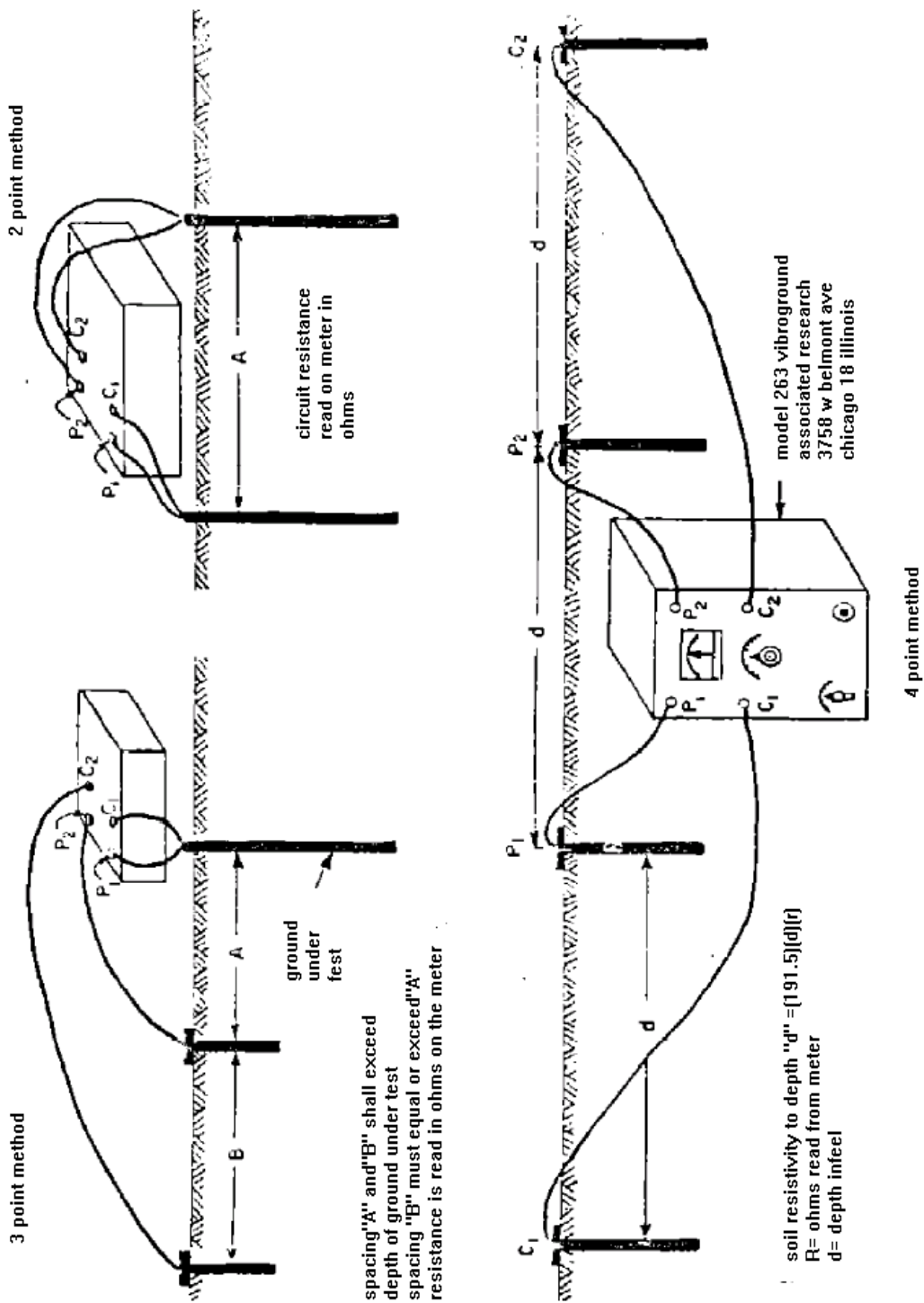

RESISTIVITY MEASUREMENT METHODS

Fig. B.1

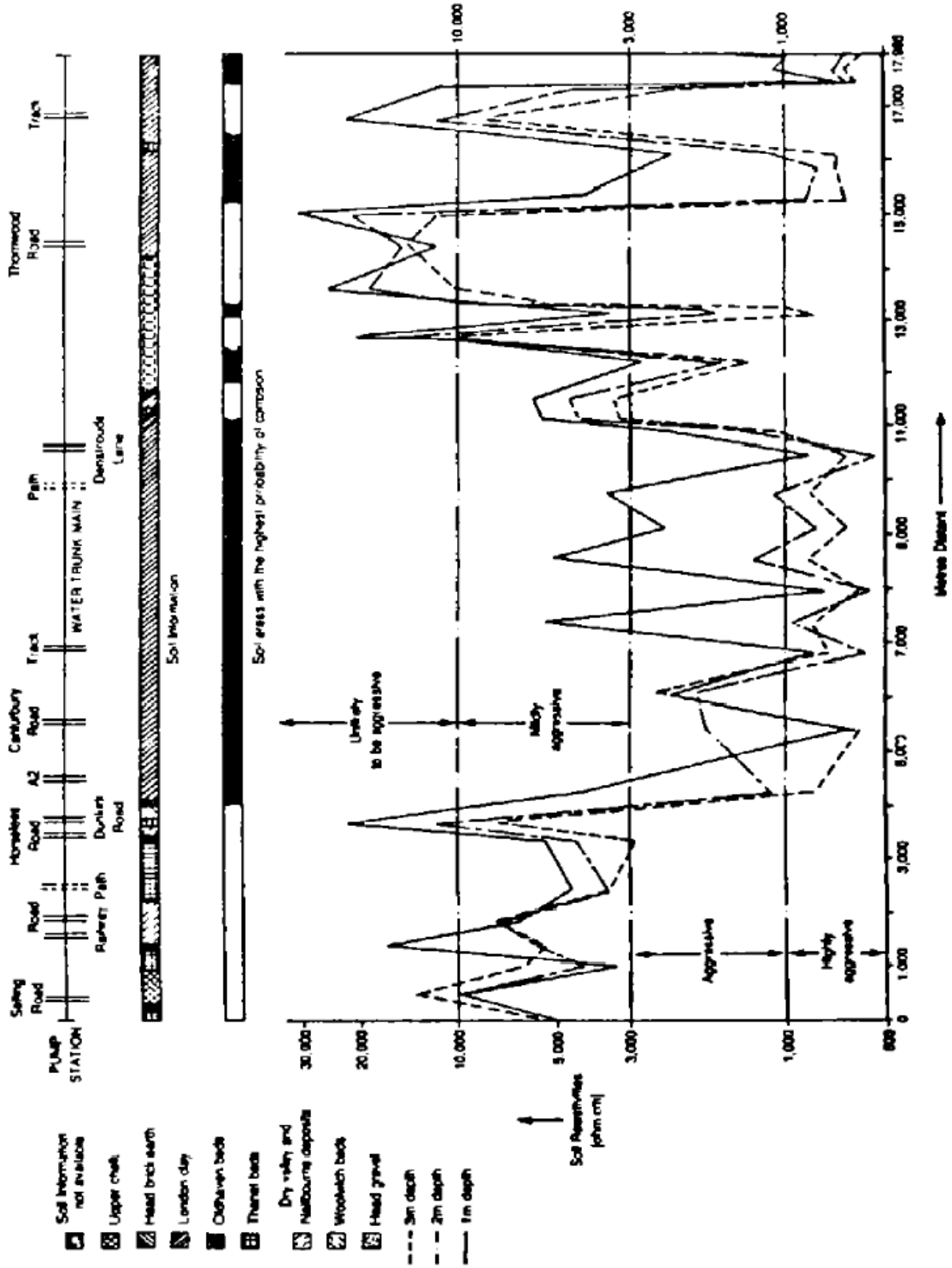

SOIL RESISTIVITY GRAPH

Fig. B.2

TABLE B.1 - SOIL CORROSION ASSESSMENT INDICES

1) German Gas Engineering Assessment Technique (for ferrous pipelines).			2) ANSI A 21.5 (AWWA C 105) Assessment Technique (for cast iron).		
Nature of Soils:	Calcareous, marls and sands	+2	Resistivity:	700 ohm-cm	10
	Loams, sandy loams and			700 - 1000 ohm-cm	8
	Sandy clays	0		1000 - 1200 ohm-cm	5
	Clays and humus	-2		1200 - 1500 ohm-cm	2
	Peat, thick loams and			1500 - 2000 ohm-cm	1
	marshy soils	-4		2000 ohm-cm	0
Resistivity	>10,000 ohm-cm	0	Redox Potential:	100 mV	0
	10,000 - 3,000 ohm-cm	-1		50 - 100 mV	3.5
	3,000 - 1,000 ohm-cm	-2		0 - 50 mV	4
	1,000 - 100 ohm-cm	-3		Negative (-)	5
	<100 ohm-cm	-4	pH	0 - 2	5
Chloride Ion	<0.005%	0		2 - 4	3
Concentration	0.005 - 0.025%	-1		4 - 6.5	0
	0.025 - 0.05%	-2		6.5 - 7.5	0*
	>0.05%	-4		7.5 - 8.5	0
Sulphate Ion	<0.02%	0		8.5	3
Concentration	0.02 - 0.05%	-1	Sulphide:	Present	3.5
	0.05 - 0.1%	-2		Trace	2
	>0.1%	-3		Not present	0
pH	>6	0	Drainage	Poor drainage continuously wet:	2
	<6	-2		Fair drainage generally moist:	1
Sulphate-Reducing	<5	0		Good drainage generally dry:	0
Bacteria:	5 - 7	-2	Assessment	10 points or more = corrosive to <u>cast iron</u>	
(Activity Index)	>7	-4			
Sulphide	None	0			
	Trace	-2			
	Present	-3			
	High	-4			
Moisture Content	<20%	0			
	>20%	-1			
Carbonate:	Copious	-2			
	Present	+1			
	Trace	0			
Soil Condition:	Existing soil	0			
	Reclaimed ground	-2			
	Same as excavated ground	0			
	Different from excavated ground	-3			
Assessment:	0	unlikely to be aggressive			
	-1 to -4	mildly aggressive			
	-5 to -10	aggressive			
	-10 and				
	above	highly aggressive			

* 3 marks shall be added if sulphide exists and Redox potential is low

NB Although this index was compiled for cast iron corrosion, it may be considered equally valid for steel pipelines.

3) British Gas Soil Corrosivity Criteria

As a result of investigations of soil corrosivity indices relating to iron pipes buried in various soils, only the parameters listed below were found to correlate with actual pipe condition.

A reduced service life for buried iron pipe is expected if:

- Backfill resistivity 2000 ohm-cm.
- and/or industrial waste present (carbonaceous).
- and/or soil pH 4.

For buried steel, cathodic protection can prevent corrosion arising from all of these effects except the presence of industrial waste.

**APPENDIX C
MEASUREMENT OF ELECTRODE RESISTANCE**

C.1 General

In some cases the voltages involved when testing earth electrodes may present a risk of shock and care should be exercised to take the necessary precautions.

Once installed, electrodes are almost certain to be connected, either deliberately or fortuitously, to other items in contact with the general mass of earth. For a new installation it is generally possible to arrange for a measurement to be made before the electrode is so connected and is still electrically isolated. For existing installations it is not permissible to disconnect earth electrodes unless the installation is also disconnected from all sources of power. The problem can sometimes be solved by installing multiple electrodes so that, with one disconnected for testing, the remaining electrodes provide an adequately low resistance.

The accuracy of measurement is subject to a number of features which should be borne in mind when assessing the implications of the value obtained. Apart from seasonal variations and trends in soil resistivity, an electrode is influenced by the presence of other conducting items in the ground, such as cables, pipes and foundations, as well as other electrodes connected together. A value obtained with existing installations, although not of great accuracy, may nevertheless provide useful information on the stability of the earthing.

For a new installation, a measurement should provide better information than a calculated value based on a measured value for the soil resistivity, because any unknown inhomogeneity in the soil is taken into account.

C.2 Measurement of Earth Electrode Resistance

Measurement of the resistance to earth of an earth electrode is not necessarily a simple matter. While certain fairly simple rules can be laid down, circumstances frequently arise which make it necessary to modify them. The resistance of an earth electrode is unique in that only the terminal provided by the electrode itself is definite, the other terminal of the resistance being theoretically at an infinite distance. In practice a measurement has to be made which includes the greater part, say 98%, of the total resistance. There is no point in striving for a high degree of accuracy with such a measurement since, within the volume of such a resistance, there may be considerable non-uniformity in the soil and other disturbing features. An accuracy of 2% is more than adequate, and accuracies of the order of 5% are usually quite acceptable.

The best method of measurement is illustrated in Fig. C.1. A measured current is passed between electrode X, the one being tested, and an auxiliary current electrode Y. The voltage drop between electrode X and a second auxiliary electrode Z is measured and the resistance of the electrode X is then the voltage between X and Z divided by the current flowing between X and Y. The source of current and the means of metering either the current and voltage or their ratio are often, but not necessarily, combined in one device.

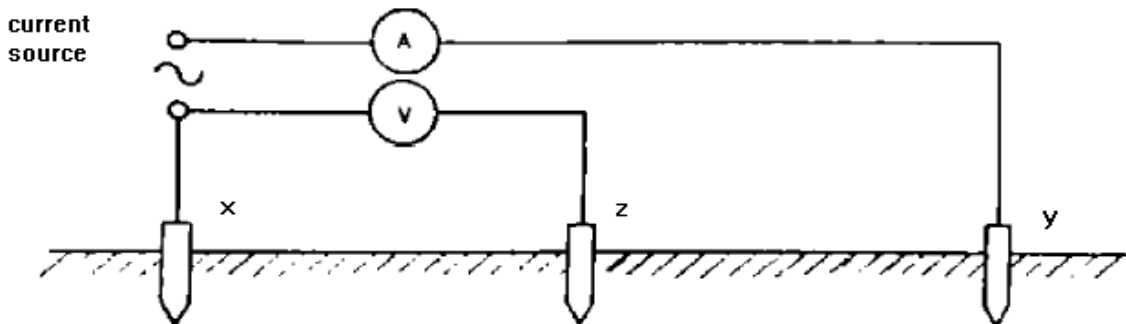

A = ammeter
V = voltmeter

MEASUREMENT OF EARTH ELECTRODE RESISTANCE

Fig. C.1

The accuracy of the measurement is influenced by the following considerations:

a) Distance between electrodes

The distance between electrodes X and Y has to be such that the resistance area of each, i.e. the area within which roughly 98% of its resistance lies, is independent of the other. If X is a

simple rod or plate Y should be placed 30 m to 50 m from X, with Z about midway between. A reading should be taken, followed by two further readings with Z moved, say, 7 m nearer to X and then 7 m nearer to Y. If the three readings give values for the resistance which agree within the accuracy required, then the mean value can be assumed to be the resistance of X.

If the results do not agree, then Y should be moved further away and the procedure repeated. This whole procedure should be repeated until the three readings do agree.

The above procedure is not satisfactory when X has a low resistance, say, 1 Ω or less. This usually occurs when X is an extended electrode or is composed of a system of electrodes which cannot be measured individually; generally occupying a large area. This problem is usually solved by obtaining earth resistance curves.

To do this Y should be placed some arbitrary distance, usually some hundreds of meters, away from X and a series of measurements made with Z at various locations along the line X-Y. If the curve of resistance plotted against the position of Z has a substantially horizontal portion, this will give the required value of resistance. If the curve does not show such a horizontal section, Y has to be moved further away from X and the process repeated until a horizontal portion is obtained (see Fig. C.2). The horizontal portion does not necessarily occur where Z is midway between X and Y. As an example, in a test on a power station electrode system, ultimately found to have a resistance of 0.05 Ω , it was necessary to place Y 700 m away and the horizontal section of the curve was found for potential electrode distances of 70 m to 100 m.

b) Interference by stray earth currents

Soil conduction is an electrolytic phenomenon and hence small dc. potentials arise between the electrodes, and stray ac. or dc potentials are picked up by the electrodes if there is a traction system in the area. Both of these forms of interference can be eliminated by testing with alternating current at a frequency different from that of the interfering power currents and their harmonics. This is usually achieved by using a frequency of about 60 Hz to 90 Hz.

If the source of power for the measurement is a hand driven generator, the frequency of the measuring current can be varied to obtain the best result. An alternating current instrument usually incorporates a synchronous rectifier or equivalent in its metering circuits so that it responds only to voltage signals of its own frequency.

c) Resistance of the auxiliary electrodes

The resistance of Y and Z are in series with the measuring and power supply circuits. These electrodes are often, for convenience, single rod electrodes which may have quite a high resistance, depending on the resistivity of the soil in which they are driven. Resistance at Y increases the power supply requirements needed to ensure an accurately measurable voltage between X and Z. Resistance at Z is in series with the voltage measuring circuit and may affect its accuracy. Information on the highest acceptable values of auxiliary electrode resistance are usually provided with instruments designed for earth resistance measurement.

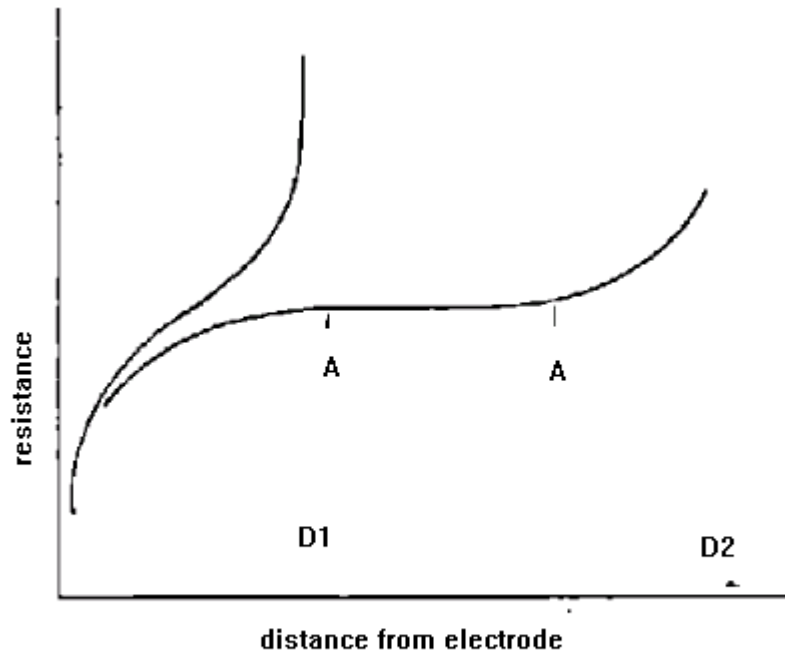

A-A practically horizontal position

EARTH RESISTANCE CURVES

Fig. C.2

C.3 Measurement of Resistance of Earthing Conductor

The following types of instrument may be used to measure the resistance of an earthing conductor:

- a) Direct reading DC ohmmeter incorporating a hand driven generator,
- b) direct reading ohmmeter supplied from a battery, or
- c) a.c. test set generally mains driven and incorporating a suitable transformer providing isolation.

Tests which give no quantitative result (e.g. bell or lamp tests) should never be used to prove the adequacy of earthing conductors.

Of the above instruments the first two differ only in the magnitude of the test current and they measure only the resistance of the conductor. A.C. mains testers can provide high test currents, but are usually limited to about 25 A because of the weight of the transformer.

An accuracy of about 5% in the measured value is desirable. To achieve such an accuracy with low resistance conductors, correct selection of the method of measurement is important and the instrument manufacturer's instructions should be consulted to confirm the conditions under which it can be achieved.

The measured impedance or resistance, except for four-terminal measurements, is usually for a loop consisting of the conductor under test, the return conductor and probably some test leads. The resistance of the conductor under test is obtained by subtracting a separately measured value for the return conductor and leads from the loop resistance. In order that this process does not introduce too great an error, the resistance of the return conductor and leads should be as low as practicable. For a similar reason all connections should be made so as to have a low resistance.

The impedance of a ferromagnetic conductor varies with the current; with the sizes of conductor likely to be involved, the highest impedance generally occurs at currents in the region of 25 A to 50A. Measurement with such a value of current will provide a worst case value, since the magnetic effect decreases as the current increases to fault current values. If measurements are made with d.c. and a substantial part of the length of the conductor is of ferrous material, it is recommended that the measured value be doubled to take account of magnetic effects.

APPENDIX D CURRENT DRAINAGE SURVEY

D.1 General

D.1.1 The current drainage survey is a technique for determining the amount of current required to provide cathodic protection to a buried pipeline and the spread of protection from a single point or the current required to boost cathodic protection on a line with deteriorating coating.

D.1.2 To obtain relevant results, pipeline isolation equipment and monitoring facilities (test points) shall be installed before current drainage tests are carried out.

D.1.3 If the pipeline has been previously cathodically protected, historical data may be used to determine the current demand.

D.2 Method

D.2.1 A temporary cathodic protection system shall be set-up using a DC power sources (e.g. batteries, portable rectifiers, etc.) timer-units, test points and one (or more) groundbed(s) in a direct current circuit.

D.2.2 After full polarization is achieved, the output shall be adjusted to provide the required drain point potential, and then maximizing the output.

D.2.3 Then, the current shall be interrupted in a sequence of e.g. 40 seconds "on", 20 seconds "off".

D.2.4 The spread can be measured by taking structure-to-soil potentials away from the drain point until loss of protection occurs.

D.2.5 The location with the least "swing" determines the required minimum output of the final installation in such a way that the minimum acceptable swing is 300 millivolt negative once the final installation is activated.*

Notes:

- 1) The current requirements for coated pipelines is often estimated.**
- 2) Current-drainage tests, although technically reliable, are generally, confined to investigations for complicated structures.**
- 3) This technique may also be used to determine the average coating resistance of a pipeline coating.**

D.3 An alternative method for determining the current required for cathodic protection is the measurement of the structure-to-electrolyte potential with stepped increase of impressed current. A graph is made showing the structure to electrolyte potential against the logarithm of the impressed current. The relationship is a straight line with a slight inclination at low currents; after a break point the curve continues as a straight line with a sharper rise at higher currents.

The break point indicates the current required to provide cathodic protection, see Fig. D.1. This method is often the only feasible one when cathodic protection is being considered for structures not fully accessible, e.g. oil well casings. As the measurements are taken in a short period, full polarization does not occur and the structure-to-electrolyte potential at the break point is not a measure of the potential required to provide protection.

The location of the half-cell in such an experiment is rather critical. A remote location should be found by moving the half-cell further away during which no significant change in potential is observed. This then is the remote potential. The potential after each current step increase shall be measured whilst interrupting the current for approximately one second and reading the instant 'off' potential. The time over which each current step increase is being applied shall be a constant (e.g. one or two minutes).

* **The ratio swing observed/swing required equals test current applied/final minimum current required.**

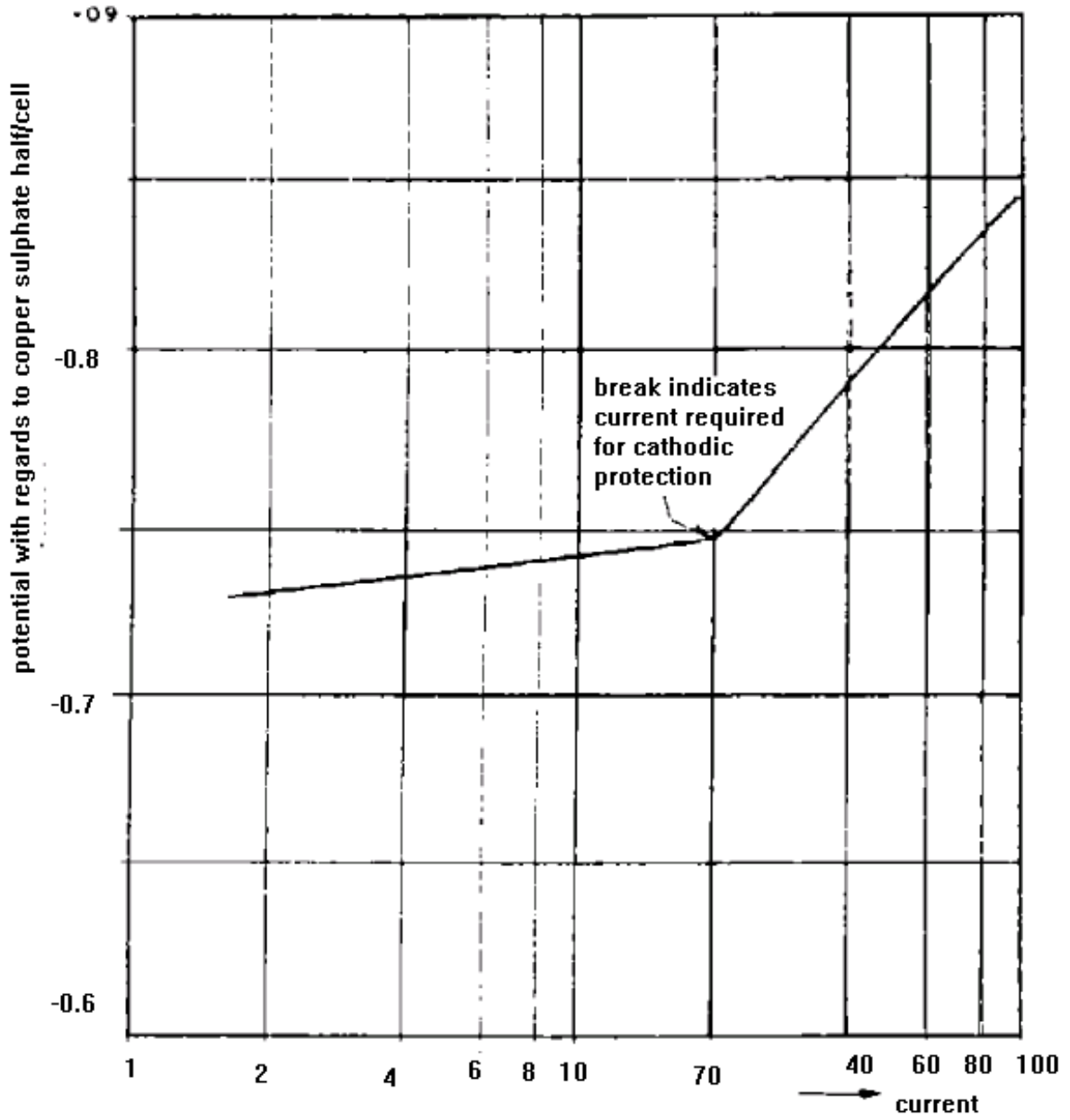

RELATIONSHIP BETWEEN POTENTIAL AND IMPRESSED-CURRENT

Fig. D.1

APPENDIX E

DETERMINATION IN-SITU OF THE REDOX POTENTIAL OF SOIL

E.1 General

This method covers the determination of the redox potential (reduction/oxidation) of soil tested in situ at a selected depth by measuring the electro-chemical potential between a platinum electrode and a saturated calomel reference electrode. The test is used to indicate the likelihood of microbial corrosion of metals by sulphate-reducing bacteria (SRB) which can proliferate in anaerobic conditions. The redox potential is principally related to the oxygen in the soil, and a high value indicates that a relatively large amount is present. Anaerobic microbial corrosion can occur if a soil has a low oxygen content and hence a low redox potential. This standard requires the use of a calomel reference probe as defined in E.2.2. This is not intended to prohibit the use of the other established portable versions of reference probes, e.g. copper/copper sulphate and silver/silver chloride (see note). In submitting reports the type of reference probe used and the correction factor applied to convert the measurement to the standard hydrogen electrode shall be given.

Redox potential may also be measured in the laboratory.

Note:

Where the other types of reference probes, e.g. copper/copper sulphate and silver/silver chloride, are used it is very important to note that their preparation and storage procedures are different from that required for calomel probes and the manufacturer's instructions should be followed. Moreover copper/copper sulphate probes are not suitable in chloride contaminated soil or in alkaline environments when silver/silver chloride should be used. Copper/copper sulphate cells are also sensitive to heat, light and a wide variety of chemicals.

The correction factors for reference probes to convert the measurement to the standard hydrogen electrode are as follows:

Mercury/mercuric chloride	240	mV	} at 25°C
Copper/copper sulphate	316	mV	
Silver/silver chloride	246	mV	

E.2 Apparatus

E.2.1 Platinum probe of a design having two separate platinum electrodes embedded in the nose piece. Also a means of protection when not in use. The probe shall have a connecting lead permitting the inclusion of each platinum electrode individually in an electrical circuit. Each connection shall be separately identified.

E.2.2 Calomel reference probe, having a mercury/mercuric chloride reference electrode which can be refilled and with a connection to a porous ceramic junction. The calomel reference electrode shall be kept clean when not in use by being stored in a sealed container. The precipitation of crystals shall be prevented when not in use, particularly at the porous junction, by storing upright and closing the breather hole.

Note:

The platinum and calomel probes are often separate and the latter made of glass which can make field use sometimes difficult. The National Corrosion Service at the National Physical

Laboratory (NPL)* has designed and supplies a robust redox probe that combines both the pair of platinum electrodes and a calomel reference probe mounted together behind a steeltipped nose cone that is fitted on the end of a steel tube which can be driven into fine- and medium-grained soils. The NPL redox probe is supplied complete with ancillary equipment for cleaning the electrodes.

* National Physical Laboratory, Teddington, Middlesex TW11 0LW, UK.

E.2.3 Calibrated millivoltmeter. The total measuring range shall be at least 0 V dc to 2 V dc with a readability at least to 10 mV. The input impedance shall be not less than 10^6 and the polarity (positive or negative) shall be marked on the two input terminals.

The instrument shall include suitable insulated flexible electric cable and connectors for use with the probes.

The instrument shall be recalibrated at intervals not exceeding 2 years.

E.2.4 Installation equipment consisting of a soil auger, spade and trowel to excavate soil to test level, and, where soil is compact, a 1 kg hammer and spike.

E.2.5 pH measuring apparatus.

E.2.6 Disturbed sample container of glass or dense plastic, that can be hermetically sealed.

Note:

When a sample from the test location is required for microbiological examination, a glass container of a size suitable to hold about 500 mL will need to have been cleaned and sterilized by scalding with boiling water beforehand. Alternatively medically sterilized plastic bags may be used. Fill the container completely and minimize air voids.

E.3 Materials

E.3.1 Saturated solution of potassium chloride in a screw-topped plastic bottle either with pouring lip suitable for filling the reservoir of the calomel reference probe or a separate small dropper or syringe 500 mL is a suitable quantity.

E.3.2 Jeweller's rouge.

E.3.3 Colorless methylated spirits, 70% by volume with 30% by volume distilled water, in a screw-topped wide-mouth bottle, 500 ml is a suitable quantity.

E.3.4 Distilled water. Two differently marked wash bottles full for cleaning platinum electrodes. 500 ml is a suitable quantity for each bottle.

E.3.5 Paper tissues and absorbent-type surgical cotton wool swabs.

E.4 Procedure

Note:

Thorough cleanliness of the probes is essential for reliable results.

E.4.1 Assemble from the storage unit according to the manufacturer's operating instructions the calomel reference probe, ensuring that the unit is full of a saturated solution of potassium chloride and that this moistens the porous junction. Remove any air bubbles in the potassium chloride

solution by gently tapping the probe and remove excess fluid from the porous junction.

Note:

During use on site it is important to prevent precipitation of crystals at the porous junction. This may be done by keeping the probe between tests in distilled water in a wide-necked bottle with a rubber bung to ensure that the porous junction is kept moist.

Clean and polish each platinum electrode. Initially smear the surfaces lightly with moist jeweller's rouge and use gentle abrasive action with cotton wool swabs. Follow with a single wash using the methylated spirits. Afterwards wash thoroughly with distilled water. Lastly dry each electrode with clean paper tissues.

Note:

Where the platinum electrode is dipped into distilled water for washing the bottles will need separate identification to select the correct sequence when reused.

E.4.2 Connect the positive terminal of the millivoltmeter with the electric cable to one of the platinum electrodes and the negative terminal to the calomel reference electrode, but leave the circuit open. This circuit shall be considered to give positive readings.

E.4.3 Test shall always be made below the level of organic growth. A hole not less than 150 mm in diameter is needed to reach the selected level when using separate probes. A combined redox probe may be driven from the surface to the selected level in weak soil, otherwise it may be necessary to auger or dig a hole part way.

E.4.4 If the probes are separate install them about 100 mm apart in the hole. The platinum probe shall penetrate at least 100 mm to ensure full soil contact below any disturbed surface material. A combined redox probe shall be pressed into position sufficiently to obtain full soil contact on the electrodes.

E.4.5 Rotate the platinum probe about a quarter turn without letting air reach the probe. Close the electric circuit then take the reading as soon as the voltage becomes stable. It may be necessary to wait 30 s or more for stable conditions to be reached. Where the probes are separate turn the platinum probe one revolution under firm hand pressure to ensure good contact. Rotate the combined redox probe a half to one revolution.

Record the reading to the nearest 10 mV when the voltage is steady and record whether it is positive or negative.

Note:

Very occasionally (rarely) the current between the platinum electrode and the reference electrode will be in the reverse direction such as to require the connections to the multimeter to be reversed. In this case the reading should be considered to be negative.

E.4.6 Transfer the electric circuit to the other platinum electrode, connecting it again to the positive terminal of the millivoltmeter, and repeat the procedure as specified in E.4.3. Record the reading to the nearest 10 mV and its polarity.

E.4.7 If the two readings differ by more than 20 mV remove the probes, reclean the platinum electrodes and re-install in a different position at the test site. Do not install the probes in the original position because oxygen will have penetrated and a false reading could result. Repeat the procedures as specified in E.4.5 and E.4.6.

E.4.8 Remove the probes and clean the electrodes taking note of the requirements of E.2.2 and E.4.1.

E.4.9 Place a disturbed sample from the position of the test in an hermetically sealed container.

E.4.10 Determine the pH of the sample by the method specified in ASTM G 51.

E.5 Calculations and Expression of the Results

The mean of the two acceptable readings and their sign shall be recorded as the potential of the platinum probe, E_p , to the nearest 10 mV. Calculate the redox potential, E_h (in mV), to the nearest 10 mV from the equation:

$$E_h = E_p + 250 + 60 (\text{pH} - 7)$$

Where:

- E_p is the potential of the platinum probe (in mV) (may be a positive or negative value);
- pH** is the value of the acidity of an aqueous solution of the soil at the test position.
- 250** is the correction factor for a calomel reference probe to convert the measurement to the standard hydrogen electrode.

E.6 Test Report

The test report shall affirm that the test was carried out in accordance with this Standard and shall contain the following information:

- a) The method of test used.
- b) The mean value of the potential (in mV) of the two platinum probes to the nearest 10 mV.
- c) The redox potential (in mV) to the nearest 10 mV.
- d) The pH value.
- e) The type of reference probe used in the test.

APPENDIX F

INSPECTION OF CP INSTALLATIONS

F.1 General

Adequate inspection during the construction of corrosion control facilities on pipelines can make the difference between first class performance (to be had if inspection is truly effective) and a system that may perform poorly and which may require relatively high maintenance expenditures if ineffective or no inspection is used.

F.2 Cathodic Protection Installations

Inspectors responsible for cathodic protection installations must be fully familiar with all details of good cathodic protection construction practice as well as with the specific provisions of the installations being made.

In some instances field modifications may be necessary. This may occur, for example, if vertical anode installations were specified but rock is closer to the surface than expected. A field decision is then necessary to determine whether the type of anode installation may be changed from vertical to horizontal or if best results will be obtained by boring the rock. Occasionally what appears to be solid rock is actually a relatively thin layer with good soil underneath. The inspector must be qualified to evaluate all such situations when encountered. Where major modifications appear advisable, he should check with the designer of the installation to be sure that the system performance will not be affected adversely.

At galvanic anode installations, one of the more particular points to be watched is the anode backfilling operation to be sure that there are no voids in the fill around the anodes. This can be a problem with packaged galvanic anodes placed vertically in augured holes. If the hole is small, it may be difficult to work earth backfill all around the anode package so that no voids backfill material can settle away from the anode, once the container has deteriorated, with probable reduction in anode effectiveness. Where anodes and chemical backfill are installed separately, the inspector must verify that the anode is centered in the hole or trench as specified and that the fill is so placed and compacted that no voids can exist.

All other details of galvanic anode installations must be verified by the inspector as being in accordance with design specification for such construction.

When inspecting impressed current groundbeds, anode placement and backfilling operations must be given careful attention to ensure installation at the design location and to avoid voids in special backfill (carbonaceous) which would tend to increase anode resistance and shorten life. Adequate compacting of carbonaceous backfill materials is important and the inspector must verify that this is done effectively but in a way that will not damage the anode proper or its connecting cable.

The most important single feature of impressed current groundbeds to be verified by the inspector is the insulation on all positive header cable, anode connecting cable and connections between the two. The inspector must be sure that no damaged cable insulation is backfilled without being repaired and that the insulation of all splices and tap connections is such that they will be permanently water-tight and such that no current leakage can occur. Likewise, the inspector must be sure that the cable trench has been so prepared that there are no materials in the trench bottom that can damage the cable insulation and that the backfill in contact with the cable is free of insulation damaging material.

When rectifier installations are involved, the inspector verifies that the rectifier unit has been placed at the specified location and in the specified manner, that all wiring is correct and that requirements of the serving power company and of local jurisdictional codes have been met. Grounding connections shall be checked.

Where power supplies other than rectifiers are used, the inspector must be familiar with the details of the specific power source specified in order that he may verify that the installation is being made properly.

F.3 Test Points, Cased Crossings and Insulating Joints

Construction of test points must be inspected to ensure their installation where called for on

construction plans, that connections to the pipeline are sound and well insulated, that color coding is observed, that wires are so placed in the ditch that backfill will not break them and that the specified terminal panel and housing is installed properly.

Insofar as corrosion control is concerned, cased crossings should be inspected as soon as they are installed. This is necessary to ascertain that the casing is electrically insulated from the carrier pipe and to permit correction of defects before backfilling.

Even though insulating joints may be installed as complete pre-assembled pre-tested units, inspection should include verification of installation at the locations indicated on the plans, that the joint is not so placed that it is subject to undue mechanical strains that could cause early failure of insulating material and that the joint is in fact serving its insulating function once welded into the line.

The inspector charged with inspecting the above features must be thoroughly familiar with the use of test points, cased crossings and insulating joints. He must be equipped with the necessary instrumentation to verify electrically the satisfactory performance of the various items prior to acceptance. He must have the authority to see that corrections are made should defects be found.

F.4 Coating Inspection

Pipeline coating inspection, rigorously applied, will result in the best practicable coating performance from the standpoint of maximum effective electrical resistance and maximum stability with time, which is what the money invested in coating is spent for. If pipeline is to be mill coated, inspection starts at the coating plant with close attention given to all phases of pipe cleaning, priming, coating, holiday testing, yard stacking and loading out for shipment by rail or truck. Additionally, material used are inspected for compliance with the coating specification and the manner in which they are stored and handled is checked for any possible adverse effect on applied coating quality. In the case of hot-applied enamels, the heating kettles are checked for proper temperature range and suitable charging and cleaning cycles. Where other coating systems are used, the application system is checked for continued satisfactory performance under conditions accepted as good practice for that type of coating system. Applied coating thickness is checked for compliance with the specification.

At the job site, inspection practices on mill coated pipe cover the unloading, hauling, stringing, joint coating, holiday testing, damage repair, lowering in and backfilling operations.

When coating application is over the ditch, the coating inspector will pay close attention to the pipe cleaning and priming machines to be assured that the prime coat will permit the best practicable bond with hot enamel or other types of field-applied coatings. Where hot-applied enamels are used, inspection of the critical dope kettle cleaning, charging and heating operations must be thorough. Materials handling techniques are inspected for assurance that materials are kept free of dirt and that wrappers particularly are kept dry. Coating machines are checked for specification coating thickness and smooth application of wrappers under correct tension with correct overlap. As with the mill coated pipe, holiday testing, damage repair, lowering in and backfilling operations are checked for adequacy.

With the varied items to be covered and the critical nature of this inspection, it becomes obvious that coating inspection responsibilities should be assigned only to personnel who are fully qualified by experience and training to do the job. Further, their responsibilities should be confined to this one inspection operation and they should have full backing by the owner to obtain immediate and positive correction in the event unsuitable practices are used in any phase of the coating operation. They must have fully adequate specifications covering the entire coating operation.

APPENDIX G

INSTALLATION IN HAZARDOUS ATMOSPHERES

G.1 General

Flammable mixtures of gas, vapor or dust may develop wherever hydrocarbons or finely divided materials are handled, stored or processed. Such hazardous atmospheres may be ignited by an electric arc or spark. Unless proper precautions are taken all electrical installations, including cathodic protection systems, will introduce the danger of sparks and ignition.

Cathodic protection systems that are to operate where flammable concentrations of gas or vapor may occur shall conform to the statutory and other safety regulations applicable to the particular structure and industry concerned, and approval shall be obtained in each individual case as appropriate. Some of the explosion hazards cathodic protection may cause and the measures needed to avoid them are described in G.2 to G.10.

G.2 Bonds

Intentional or unintentional disconnection of bonds across pipeline joints or any other associated equipment under protection or fortuitously bonded to protected equipment constitutes a hazard.

To avoid the hazard, bonds shall be installed outside the hazardous area or in a protected position to avoid an unintentional break. The cathodic protection supply shall be switched off or disconnected by means of a flameproof switch.

G.3 Isolating Joints

Intentional or unintentional short-circuit of isolating joints e.g. by tools, or breakdown due to voltage surges on the protected structure induced by lightning or electrical power faults constitute a hazard.

To avoid the hazard, isolating joints shall, if possible, be located outside the hazardous area. Where this is not practicable, measures shall be adopted to avoid arcing or sparking. These will include the use of resistance bonds fitted in a flameproof enclosure or located outside the hazardous area, an encapsulated spark gap or surge diverter, zinc earth electrodes connected to each side of the isolating joint or polarization cell connected across the isolating joint, or to earth. The surfaces of the isolating joint shall be insulated to prevent fortuitous short circuiting by tools.

G.4 Short-Circuits Between Points of Different Potentials

Unintentional short-circuits by fortuitous bridging of points of different potential, e.g. by metal scraps, odd lengths of wire, mobile plant constitute a hazard.

This hazard is difficult to foresee but may be limited by bonding all metalwork together to minimize the potential difference between different parts of the structure.

G.5 Disconnection, Separation or Breaking of Protected Pipework

Cathodically protected pipework will have a portion of the protection current flowing through it. Any intentional disconnection, separation or breaking of the pipework will interrupt the current flow and may produce arcing depending on the magnitude of the current.

During any modification, maintenance or repair of cathodically protected pipework, transformer-rectifiers that affect that section of pipework shall be switched off and a temporary continuity bond attached across any intended break. It is essential that the bond is securely clamped to each side of the intended break and remains connected until the work is completed and electrical continuity restored or until the area is certified as gas-free or non-hazardous.

G.6 Electrical Equipment

All electrical equipment installed in a hazardous area shall be flameproof and certified for use in that area. To avoid the need for flameproof equipment, the equipment shall be located outside the hazardous area. Double pole switches shall be provided in each circuit entering a hazardous area to ensure that both poles are isolated during maintenance etc. (see also G.5). It is essential that any cables carrying cathodic protection current shall be installed in such a manner that disconnection cannot take place within the hazardous area without de-energizing the cathodic protection system. The cables also be adequately protected mechanically to prevent accidental breakage.

G.7 Test Instruments

The connection and disconnection of instruments used for measuring and testing cathodic protection systems may produce arcing or sparking. Where measurements are taken within the hazardous areas, the meter used shall be intrinsically safe. The test leads shall be connected to the structure before being connected to the meter. Alternatively, the area shall be tested and declared gas-free, allowing conventional instruments to be used. Consideration may also be given to the use of permanently installed reference electrodes and test leads with the cables taken outside the hazardous area where conventional instruments can be used.

G.8 Internal Anodes

Unintentional short-circuiting of impressed current anodes when the liquid level is lowered in plant under internal cathodic protection can constitute a hazard.

Arrangements shall be made to ensure that the circuit is automatically or manually isolated when the anode is not submerged, i.e. when the anode circuit becomes an open circuit.

G.9 Sacrificial Anodes

Whilst the normal operation of sacrificial anode not considered hazardous, there is a danger of incendive sparking if a suspended or supported sacrificial magnesium or aluminum anode or portion of anode becomes detached and falls onto steel. This risk is not present with zinc anodes.

G.10 Instruction of Personnel

In locations where any of the above hazards may occur, it is essential that operating personnel be suitably instructed, and durable warning notices shall be authoritatively displayed as appropriate. Suitable written procedures and work authorization permits shall be included in the operations manual.